



COMPLETE LINE OF
**FLEXIBLE
POLY BAG
PACKAGING**



CONTACT US FOR
MORE INFORMATION

ALTA-PAK MIDWEST
3401 NORTH JACKSON AVE
KANSAS CITY, MO 64117

TO REORDER CALL 816-453-7204

POLY BAGS, FILM AND TUBING

CONTENTS

3	Layflat Poly Bags	27	Bin & Gaylord Liners/Pallet Covers
4	Layflat Poly Bags	28	Bin & Gaylord Liners/Pallet Covers
5	Layflat Poly Bags	28	Shrink Bags & Film
6	Layflat Poly Bags	29	Berry Machine Stretch Film
8	Gusseted Bags in Cases	29	Stretch Film By Berry
9	Gusseted Bags on Rolls	30	Berry Hand Stretch Film
10	Suffocation Warning Bags	31	High-Density (HD) Liners
11	Pre-Opened Bags on Rolls	32	Linear Low-Density Liners
12	Specialty Retail Bags	33	Linear Low-Density Liners
13	Specialty Bags	34	Polypropylene Bags
14	Specialty Bags	35	Stand Up Pouches
15	Static Control	36	Vacuum Pouches
16	Static Control	37	Wicketed Bags
17	Reclosable Bags	38	Specialty Food Bags
18	Reclosable Bags	38	Ice Bags
19	Reclosable Bags	38	Saddle Pack Deli Bags
20	Packing List Envelopes	38	Sandwich & Silverware Bags
20	Postal-Approved Lip & Tape Bags	39	ARMOR VCI
21	Poly Mailers	43	Printing
22	Custom Poly Mailers	45	Measuring for the Right Size
23	Poly Tubing	46	Custom Manufacturing
24	Poly Tubing		
24	Poly Sleeves		
25	Construction Film		
26	Sheeting		

CONTACT US FOR
MORE INFORMATION

ALTA-PAK MIDWEST
3401 NORTH JACKSON AVE
KANSAS CITY, MO 64117

TO REORDER CALL 816-453-7204



LAYFLAT POLY BAGS

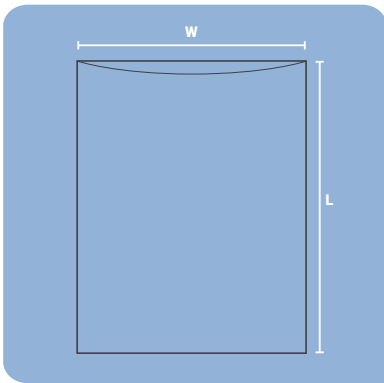

THE BASICS

Our Layflat Poly Bags are designed for a wide range of uses and exhibit extreme durability. Produced with our state-of-the-art manufacturing equipment, they offer superior bottom seal and side weld constructions.

ENHANCED CLARITY & STRENGTH

Built utilizing high grade polyethylene resin and advanced blending techniques, these bags exhibit enhanced clarity and tensile strength.

CHOOSE FROM 7 THICKNESSES

- Light weight – 1, 1.25, 1.5 mil
- Medium weight – 2 mil
- Heavy weight – 3 mil
- Extra-heavy weight – 4 mil
- Super-heavy weight – 6 mil

TECHNICAL DETAILS

Made from 100% virgin Low-Density Polyethylene that meets FDA/USDA specifications. These are heat sealable and feature a bottom seal or side weld construction.

1 MIL LAYFLAT

ITEM	W x L	CNT	WT
2200	3 X 3	1000	1
2202	3 X 4	1000	2
2205	3 X 5	1000	2
2204	3 X 6	1000	2
2206	3 X 8	1000	2
2207	3 X 10	1000	3
2208	3 X 12	1000	3
2209	3 X 16	1000	4
2210	4 X 4	1000	2
2211	4 X 5	1000	2
2215	4 X 6	1000	2
2216	4 X 7	1000	2
2220	4 X 8	1000	3
2225	4 X 10	1000	3
2222	4 X 12	1000	4
2224	4 X 16	1000	5
2229	5 X 6	1000	2
2230	5 X 7	1000	3
2235	5 X 8	1000	3
2240	5 X 10	1000	4
2245	5 X 12	1000	5
2246	5 X 16	1000	6
2250	6 X 6	1000	3
2255	6 X 8	1000	4
2260	6 X 9	1000	4
2265	6 X 10	1000	4
2270	6 X 12	1000	5
2256	6 X 14	1000	6
2259	6 X 20	1000	8
2272	7 X 7	1000	4
2273	7 X 8	1000	5
2274	7 X 9	1000	5
2275	7 X 10	1000	5
2276	7 X 12	1000	6
2277	7 X 14	1000	7
2278	7 X 16	1000	8
2279	7 X 18	1000	8
2280	8 X 8	1000	5
2285	8 X 10	1000	6
2290	8 X 12	1000	7
2295	8 X 14	1000	8
2300	8 X 16	1000	9
2301	8 X 18	1000	9
2302	8 X 20	1000	10

1 MIL LAYFLAT

ITEM	W x L	CNT	WT
2303	8 X 24	1000	12
2308	9 X 10	1000	7
2305	9 X 12	1000	8
2310	9 X 14	1000	8
2315	9 X 16	1000	9
2320	9 X 18	1000	11
2325	10 X 10	1000	7
2330	10 X 12	1000	8
2335	10 X 14	1000	9
2340	10 X 16	1000	11
2345	10 X 18	1000	12
2346	10 X 20	1000	13
2347	10 X 24	1000	15
2351	11 X 12	1000	9
2352	11 X 14	1000	10
2353	11 X 16	1000	12
2354	11 X 18	1000	13
2350	12 X 12	1000	10
2355	12 X 14	1000	11
2358	12 X 15	1000	12
2360	12 X 16	1000	12
2365	12 X 18	1000	14
2370	12 X 20	1000	15
2371	12 X 24	1000	18
2373	12 X 36	1000	27
2378	13 X 14	1000	12
2379	13 X 16	1000	14
2381	13 X 20	1000	17
2375	14 X 14	1000	12
2380	14 X 16	1000	15
2385	14 X 18	1000	16
2390	14 X 20	1000	18
2391	14 X 24	1000	21
2392	14 X 30	1000	26
2396	15 X 15	1000	15
2397	15 X 18	1000	17
2398	15 X 24	1000	23
2395	16 X 16	1000	16
2400	16 X 18	1000	20
2405	16 X 20	1000	22
2406	16 X 24	1000	26
2407	16 X 30	1000	33
2409	16 X 40	1000	43
2410	18 X 18	1000	22

1 MIL LAYFLAT

ITEM	W x L	CNT	WT
2415	18 X 24	1000	27
2416	18 X 30	1000	33
2420	20 X 20	1000	25
2425	20 X 24	1000	30
2426	20 X 30	1000	37
2427	20 X 36	500	22
2428	20 X 42	500	26
2430	24 X 24	1000	36
2435	24 X 30	500	22
2440	24 X 36	500	27
2443	26 X 26	1000	42
2444	26 X 30	500	24
2446	26 X 36	500	29
2449	28 X 36	500	31
2445	30 X 30	500	28
2450	30 X 36	500	34
2452	30 X 42	500	39
2455*	36 X 36	500	40
2460*	40 X 46	250	29
2470*	44 X 48	250	33
2475*	48 X 48	250	36

1.25 MIL LAYFLAT

ITEM	W x L	CNT	WT
2754	4 X 5	1000	2
2778	6 X 9	1000	5
2782	6 X 12	1000	6
2798	8 X 10	1000	7
2818	9 X 12	1000	9
2830	10 X 14	1000	11
2854	12 X 14	1000	14
2856	12 X 16	1000	16
2858	12 X 18	1000	17
2878	14 X 18	1000	21
2902	16 X 20	1000	27
2912	18 X 20	1000	31
2914	18 X 24	1000	34
2936	24 X 30	500	27
2938	24 X 36	500	33
2982*	40 X 60	250	45



ENGINEERED AND MANUFACTURED IN THE U.S.A.

CONTACT US FOR MORE INFORMATION

ALTA-PAK MIDWEST
3401 NORTH JACKSON AVE
KANSAS CITY, MO 64117

TO REORDER CALL 816-453-7204

LAYFLAT POLY BAGS

2 MIL LAYFLAT

ITEM	W x L	CNT	WT
626*	24 X 42	250	31
627*	24 X 48	250	35
628*	24 X 60	250	43
621*	26 X 26	500	41
623*	26 X 36	250	28
624*	26 X 42	250	33
629*	26 X 48	250	38
631*	28 X 28	500	47
632*	28 X 32	250	27
633*	28 X 36	250	31
634*	28 X 40	250	34
639*	28 X 48	250	40
641*	28 X 60	200	40
630*	30 X 30	250	27
635*	30 X 36	250	33
636*	30 X 42	250	38
637*	30 X 48	250	43
638*	30 X 60	200	43
642*	32 X 32	250	31
643*	32 X 40	250	39
646*	32 X 48	200	37
647*	32 X 56	200	43
648*	34 X 36	250	37
649*	34 X 40	250	41
651*	34 X 48	200	39
640*	36 X 36	250	39
645*	36 X 42	200	37
650*	36 X 48	200	42
652*	36 X 60	100	26
656*	38 X 42	200	39
3147*	38 X 60	100	28
3148*	38 X 65	100	30
654*	40 X 42	200	40
655*	40 X 48	100	23
657*	40 X 54	100	26
660*	40 X 60	100	29
661*	44 X 48	100	26
663*	44 X 60	100	32
665*	48 X 48	100	28
667*	48 X 54	100	31
670*	48 X 60	100	35
674*	56 X 60	100	40

3 MIL LAYFLAT

ITEM	W x L	CNT	WT
675	2 X 3	1000	2
680	2 X 4	1000	2
681	2 X 6	1000	3
682	2 X 8	1000	4
690	3 X 3	1000	2
695	3 X 4	1000	3
700	3 X 5	1000	4
705	3 X 6	1000	4
710	3 X 8	1000	5
711	3 X 10	1000	6
712	3 X 12	1000	7
715	4 X 4	1000	4
720	4 X 5	1000	4
725	4 X 6	1000	5
727	4 X 7	1000	6
730	4 X 8	1000	6
735	4 X 10	1000	8

3 MIL LAYFLAT

ITEM	W x L	CNT	WT
740	4 X 12	1000	9
736	4 X 14	1000	11
741	4 X 16	1000	13
746	5 X 5	1000	6
747	5 X 6	1000	6
745	5 X 7	1000	7
750	5 X 8	1000	8
748	5 X 9	1000	9
755	5 X 10	1000	10
760	5 X 12	1000	11
765	6 X 6	1000	7
766	6 X 7	1000	8
770	6 X 8	1000	9
775	6 X 9	1000	11
780	6 X 10	1000	12
785	6 X 12	1000	15
782	6 X 14	1000	17
786	6 X 16	1000	20
783	6 X 18	1000	22
788	6 X 24	1000	27
793	7 X 8	1000	11
794	7 X 9	1000	13
790	7 X 10	1000	14
796	7 X 12	1000	17
797	7 X 16	1000	23
795	8 X 8	1000	13
800	8 X 10	1000	15
805*	8 X 12	1000	17
807*	8 X 14	1000	20
810*	8 X 16	1000	23
811*	8 X 20	1000	29
814*	9 X 10	1000	16
815*	9 X 12	1000	20
820*	9 X 14	1000	23
825*	9 X 16	1000	26
835*	10 X 10	1000	18
840*	10 X 12	1000	22
845*	10 X 14	1000	25
846*	10 X 15	1000	27
850*	10 X 16	1000	29
855*	10 X 18	1000	32
856*	10 X 20	1000	36
857*	10 X 24	1000	43
859*	10 X 36	500	32
860*	12 X 12	1000	26
865*	12 X 14	1000	30
866*	12 X 15	1000	32
870*	12 X 16	1000	34
875*	12 X 18	1000	39
880*	12 X 20	1000	43
885*	12 X 24	500	26
888*	12 X 36	500	39
889*	14 X 14	1000	35
890*	14 X 16	1000	40
895*	14 X 18	1000	45
900*	14 X 20	500	25
901*	14 X 24	500	30
908*	15 X 20	500	27
909*	15 X 24	500	32
912*	15 X 36	250	24
904*	16 X 16	1000	46
905*	16 X 18	500	26
910*	16 X 20	500	29
915*	16 X 24	500	34

3 MIL LAYFLAT

ITEM	W x L	CNT	WT
916*	16 X 28	500	40
917*	16 X 30	500	43
922*	18 X 20	500	32
925*	18 X 24	500	39
930*	18 X 30	250	24
931*	18 X 36	250	29
935*	20 X 20	500	36
940*	20 X 24	250	22
945*	20 X 30	250	27
946*	20 X 36	250	32
947*	20 X 42	250	38
924*	22 X 30	250	30
926*	22 X 36	250	35
950*	24 X 24	250	26
951*	24 X 26	250	28
955*	24 X 30	250	32
960*	24 X 36	250	39
961*	24 X 42	250	45
962*	24 X 48	200	41
953*	26 X 26	250	30
954*	26 X 30	250	35
956*	26 X 36	250	42
964*	28 X 32	250	40
966*	28 X 36	200	36
967*	28 X 40	100	20
965*	30 X 30	250	40
970*	30 X 36	200	39
971*	30 X 42	100	23
972*	30 X 48	100	26
977*	32 X 40	100	23
983*	34 X 40	100	25
975*	36 X 36	100	23
980*	36 X 42	100	27
985*	36 X 48	100	31
986*	36 X 60	100	39
988*	38 X 42	100	29
3150*	38 X 60	100	41
3151*	38 X 64	100	44
3152*	38 X 65	100	44
990*	40 X 48	100	35
992*	40 X 54	100	39
997*	44 X 60	50	24
1000*	48 X 48	100	41
1002*	48 X 54	100	47
1005*	48 X 60	50	26
1007*	52 X 60	50	28

4 MIL LAYFLAT

ITEM	W x L	CNT	WT
1010	2 X 3	1000	3
1015	2 X 4	1000	3
1017	2 X 6	1000	4
1019	2 X 8	1000	5
1021	2 X 10	1000	6
1025	3 X 3	1000	3
1030	3 X 4	1000	4
1035	3 X 5	1000	5
1040	3 X 6	1000	5
1045	3 X 8	1000	6
1046	3 X 10	1000	8
1047	3 X 12	1000	9
1048	3 X 18	1000	14
1050	4 X 4	1000	5
1055	4 X 5	1000	6

4 MIL LAYFLAT

ITEM	W x L	CNT	WT
1060	4 X 6	1000	7
1062	4 X 7	1000	8
1065	4 X 8	1000	9
1070	4 X 10	1000	11
1075	4 X 12	1000	12
1074	4 X 18	1000	18
1077	4 X 20	1000	20
1078	4 X 24	1000	24
1079	5 X 5	1000	7
1081	5 X 6	1000	8
1080	5 X 7	1000	9
1085	5 X 8	1000	10
1090	5 X 10	1000	13
1095	5 X 12	1000	15
1083	5 X 14	1000	18
1092	5 X 18	1000	22
1096	5 X 28	1000	34
1100	6 X 6	1000	10
1101	6 X 7	1000	11
1105	6 X 8	1000	12
1110	6 X 9	1000	13
1115	6 X 10	1000	15
1120*	6 X 12	1000	18
1102*	6 X 14	1000	21
1121*	6 X 16	1000	23
1123*	6 X 24	1000	35
1124*	6 X 30	1000	43
1106	7 X 7	1000	13
1107	7 X 8	1000	14
1108*	7 X 9	1000	15
1125*	7 X 10	1000	17
1126*	7 X 12	1000	21
1127*	7 X 14	1000	24
1130	8 X 8	1000	16
1135*	8 X 10	1000	20
1140*	8 X 12	1000	23
1142*	8 X 14	1000	27
1145*	8 X 16	1000	31
1136*	8 X 18	1000	35
1147*	8 X 24	1000	46
1137*	8 X 28	500	27
1150*	9 X 12	1000	26
1160*	9 X 16	1000	35
1165*	9 X 18	1000	39
1170*	10 X 10	1000	24
1175*	10 X 12	1000	29
1180*	10 X 14	1000	34
1181*	10 X 15	1000	36
1185*	10 X 16	1000	38
1190*	10 X 18	1000	43
1191*	10 X 20	1000	48
1192*	10 X 24	500	29
1193*	10 X 30	500	36
1186*	11 X 16	1000	42
1187*	11 X 18	500	24
1195*	12 X 12	1000	35
1200*	12 X 14	1000	40
1201*	12 X 15	1000	43
1205*	12 X 16	500	23
1210*	12 X 18	500	26
1215*	12 X 20	500	29
1220*	12 X 24	500	35
1222*	12 X 30	500	43
1223*	12 X 36	250	26

4 MIL LAYFLAT

ITEM	W x L	CNT	WT
1224*	14 X 14	1000	47
1225*	14 X 16	500	27
1230*	14 X 18	500	31
1235*	14 X 20	500	34
1236*	14 X 24	500	42
1237*	14 X 30	250	25
1238*	14 X 36	250	31
1242*	15 X 15	500	27
1243*	15 X 18	500	33
1246*	15 X 24	500	43
1247*	15 X 30	250	27
1239*	16 X 16	500	31
1240*	16 X 18	500	35
1245*	16 X 20	500	39
1250*	16 X 24	500	46
1249*	16 X 28	250	27
1251*	16 X 30	250	29
1252*	16 X 36	250	35
1255*	18 X 18	500	39
1257*	18 X 20	500	43
1260*	18 X 24	250	26
1265*	18 X 30	200	26
1266*	18 X 36	200	31
1270*	20 X 20	250	24
1275*	20 X 24	250	29

ISO 9001 QUALITY

We are ISO 9001 Quality Registered. This means every bag we make must pass multiple quality inspections before it's shipped to you. The lot number on every case allows us to track and document the purity of the raw material and its exact specifications.



CONTACT US FOR MORE INFORMATION

ALTA-PAK MIDWEST
3401 NORTH JACKSON AVE
KANSAS CITY, MO 64117

TO REORDER CALL 816-453-7204

LAYFLAT POLY BAGS

4 MIL LAYFLAT CASES

ITEM	W x L	CNT	WT
1280*	20 X 30	250	36
1281*	20 X 36	250	43
1282*	20 X 42	200	41
1283*	20 X 48	200	46
1261*	22 X 24	250	32
1262*	22 X 30	250	40
1285*	24 X 24	250	35
1290*	24 X 30	250	43
1295*	24 X 36	200	42
1296*	24 X 42	200	48
1297*	24 X 48	100	28
1298*	24 X 60	100	35
1287*	26 X 26	250	41
1288*	26 X 30	200	37
1289*	26 X 36	200	45
1291*	26 X 42	100	27
1294*	28 X 32	200	43
1299*	28 X 36	100	25
1301*	28 X 40	100	27
1300*	30 X 30	200	43
1305*	30 X 36	100	26
1306*	30 X 42	100	30
1307*	30 X 48	100	35
1308*	30 X 60	100	43
1304*	32 X 32	100	25
1309*	32 X 40	100	31
1311*	32 X 44	100	34
1312*	32 X 48	100	37
1313*	32 X 56	100	43
1316*	34 X 40	100	33
1317*	34 X 48	100	39
1310*	36 X 36	100	31
1315*	36 X 42	100	37
1320*	36 X 48	100	42
1322*	36 X 60	50	26
1319*	38 X 48	100	44
3155*	38 X 60	50	28
3302*	38 X 64	50	30
8727*	38 X 65	50	30
1324*	40 X 42	100	41
1325*	40 X 48	50	23
1327*	40 X 54	50	26
1330*	40 X 60	50	29
1331*	44 X 48	50	26
1335*	48 X 48	50	28
1337*	48 X 54	50	31
1340*	48 X 60	50	35
1342*	52 X 60	50	38
1344*	56 X 60	50	41

6 MIL LAYFLAT CASES

ITEM	W x L	CNT	WT
8135	4 X 6	1000	10
8145	4 X 10	1000	16
8185	5 X 7	1000	14
8190	5 X 8	1000	15
8220	6 X 8	1000	19
8225	6 X 9	1000	21
8230	6 X 10	1000	23
8235	6 X 12	1000	28
8270*	7 X 10	1000	27
8280*	7 X 14	1000	37
8290*	8 X 8	1000	24
8295*	8 X 10	1000	30
8300*	8 X 12	1000	36
8350*	9 X 12	1000	41
8355*	9 X 14	500	24
8360*	9 X 16	500	27
8385*	10 X 12	1000	45
8390*	10 X 14	500	27
8395*	10 X 16	500	30
8400*	10 X 18	500	34
8410*	10 X 24	500	45
8435*	12 X 12	500	27
8440*	12 X 14	500	32
8445*	12 X 16	500	36
8450*	12 X 18	500	41
8455*	12 X 20	500	45
8465*	12 X 30	250	34
8500*	14 X 16	500	42
8505*	14 X 18	250	24
8510*	14 X 20	250	27
8515*	14 X 24	250	32
8520*	14 X 30	250	40
8545*	16 X 18	250	28
8550*	16 X 20	250	30
8555*	16 X 24	250	36
8560*	16 X 30	250	45
8570*	18 X 18	250	31
8580*	18 X 24	250	41
8585*	18 X 30	200	41
8590*	18 X 36	100	25
8600*	20 X 20	250	38
8605*	20 X 24	250	45
8610*	20 X 30	200	45
8615*	20 X 36	100	28
8625*	24 X 24	200	44
8630*	24 X 30	100	28
8635*	24 X 36	100	33
8645*	24 X 48	100	44
8655*	28 X 32	100	34
8670*	28 X 48	50	26
8685*	30 X 36	100	41
8700*	30 X 60	50	34
8705*	36 X 36	50	25
8710*	36 X 48	50	33
8715*	36 X 60	50	41
8720*	38 X 48	50	35
8725*	38 X 60	50	43
8730*	38 X 65	50	47

BAGS ON ROLLS

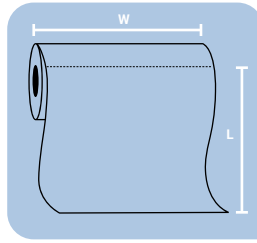

THE BASICS

Our Bags on Rolls demonstrate exceptional clarity for increased visibility. Ideal for hand loading product, these are manufactured with a perforation between the bags for easy dispensing.

- ▶ Easy to store – hang anywhere
- ▶ Bags stay neat – never folded

TECHNICAL DETAILS

Made from 100% virgin Low-Density Polyethylene (LDPE) that meets FDA/USDA specifications. These are heat sealable and feature a bottom seal construction. Rolls have 3" cores.

2 MIL LAYFLAT ON ROLLS

ITEM	W x L	CNT	WT
7715*	6 X 9	2000	14
7720*	8 X 10	1000	11
7725*	9 X 12	1000	14
7730*	10 X 16	1000	20
7735*	12 X 18	1000	27
7740*	16 X 20	1000	39
7745*	18 X 24	500	27
7750*	20 X 30	500	37
7751*	24 X 24	500	36
7753*	24 X 30	500	45
7755*	24 X 36	500	53
7760*	30 X 42	250	40
7765*	36 X 48	250	54
7770*	40 X 54	200	54
7775*	48 X 60	150	55

3 MIL LAYFLAT ON ROLLS

ITEM	W x L	CNT	WT
6905*	38 X 65	100	44

4 MIL LAYFLAT ON ROLLS

ITEM	W x L	CNT	WT
6820*	8 X 10	500	11
6825*	9 X 12	500	14
6830*	10 X 16	500	20
6835*	12 X 18	500	27
6845*	18 X 24	250	27
6850*	20 X 30	250	37
6855*	24 X 36	250	53
6860*	30 X 42	125	40
6865*	36 X 48	125	54
6919*	38 X 64	50	29
6920*	38 X 65	50	30
6875*	48 X 60	75	55

ROLL DISPENSERS

Made of steel, these can accommodate a roll of up to 13.5" in diameter.

ITEM	SIZE	CNT	WT
4830	12"	1	2
4832	24"	1	3



DURABLE BOTTOM SEALS & WELDS

Our state-of-the-art manufacturing equipment produces high strength bottom seal and side weld constructions. We take special pride in the durability we build into each bag.

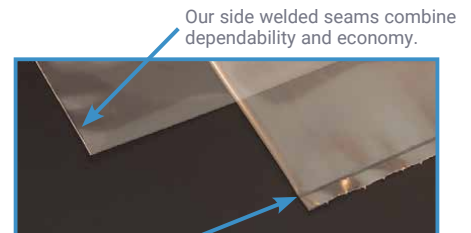

Precision bottom seals combined with tubular construction offer maximum strength.

***smart tech bags®**

ENGINEERED AND MANUFACTURED
IN THE U.S.A.

CONTACT US FOR
MORE INFORMATION

ALTA-PAK MIDWEST
3401 NORTH JACKSON AVE
KANSAS CITY, MO 64117

TO REORDER CALL 816-453-7204

Layflat and Gusseted

CUSTOM CAPABILITIES

With over 58 extrusion lines in 5 manufacturing facilities, we can produce a wide range of custom LDPE and LLDPE bags, sheeting and tubing. Choose from 16 standard colors, 3 venting styles and a host of performance additives.

MADE IN THE U.S.A.

Medium and larger sized items are engineered with optimized clarity and strength to provide over three times the impact and twice the tensile strength of traditional LDPE. These products are exclusively made in the U.S.A. by an ISO 9001 manufacturer using 100% renewable energy from sources like wind and solar.



PRINTED BAGS

You can design, quote and order printed items with your own custom images. Quotes are generated quickly and include precise technical line drawings that include your image and text sized to scale, ready for sharing as a PDF attachment.

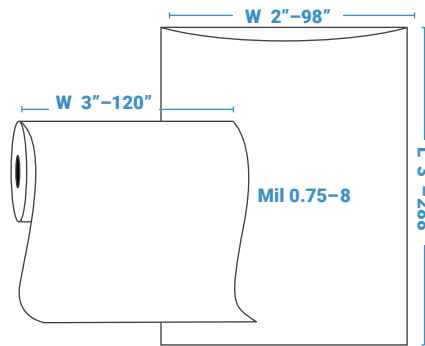

CUSTOM VENTING

Vented Bags W: 4"–98" W+D max. = 150"
Micro-Perforation W: 10"–60" W+D max. = 118"

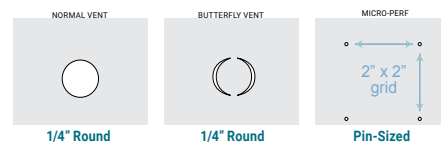
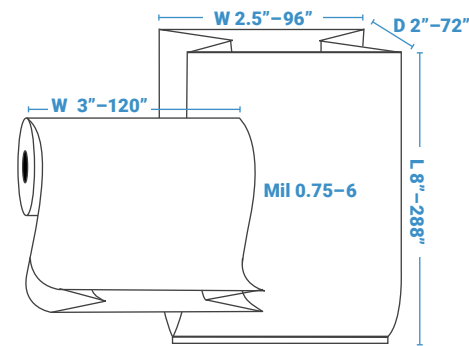

MATERIALS & ADDITIVES

- Anti-Block** For easy opening and loading
- Anti-Static** For static-dissipative film
- Clarity** For improved visibility through film
- HDPE** High-Density Polyethylene for thinner, more economical film
- High Slip** For reduced friction between film
- LDPE** Low-Density Polyethylene for standard strength film
- LLD** High Strength Linear Low-Density
- LLDPE** Linear Low-Density Polyethylene for high strength film
- Metalocene** For high strength film or cold storage
- Non-Slip** To increase friction between film
- Non-Scratch** No anti-block for a smoother film surface
- Postal-Approved** Higher slip & anti-static for film used in USPS mailings
- UVI/UVA** Ultraviolet Inhibitor/Absorber to protect film and contents from the sun
- VCI** Vapor Corrosion Inhibitor to prevent rust

PACKAGING DETAILS

- Cases or Rolls** Loose in a case or on a roll for easy dispensing
- Case or Roll Count** Get the quantity that works best for your customer
- Boxed Rolls** Protect product prior to use
- Cradle Packed Rolls** Use less packaging, save money and provide more stable shipments
- Tray-Packed Rolls** Use less packaging, saves time unpacking

FILM COLORS (SWATCHES ARE APPROXIMATE)



Tint For film that you can see through in interior light
Color For film you may not see through in interior light
Opaque For film you cannot see through in interior light (black film only, minimum thickness 2.5 mil)

CONTACT US FOR
MORE INFORMATION

ALTA-PAK MIDWEST
3401 NORTH JACKSON AVE
KANSAS CITY, MO 64117

TO REORDER CALL 816-453-7204

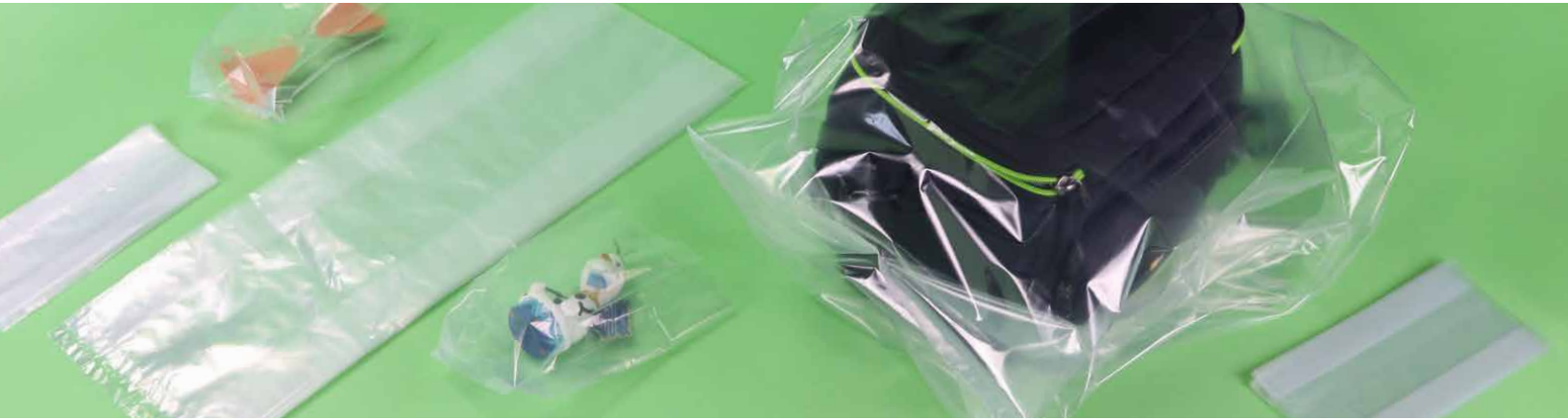

GUSSETED BAGS IN CASES

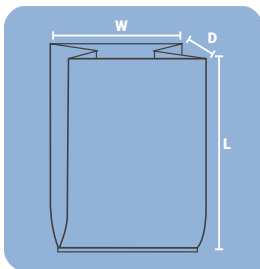

THE BASICS

Our Gusseted Bags are ideal for bulky or larger sized items and suitable for a wide range of applications. Like our Layflat Bags, these are manufactured with superior clarity and strength and maintain a durable bottom seal.

TECHNICAL DETAILS

Made from 100% virgin Low-Density Polyethylene (LDPE) that meets FDA/USDA specifications. These are heat sealable and feature a bottom seal construction.



ENGINEERED AND MANUFACTURED IN THE U.S.A.

1 MIL GUSSETED

ITEM	WxDxL	CNT	WT
1345	4 X 2 X 8	1000	4
1347	4 X 2 X 10	1000	4
1350	4 X 2 X 12	1000	5
1355	5 X 2 X 12	1000	6
1360	5 X 3 X 15	1000	8
1361	5 X 3.5 X 12	1000	7
1363	5 X 4 X 15	1000	9
1378	5.5 X 4.75 X 19	1000	13
1366	6 X 3 X 12	1000	7
1365	6 X 3 X 15	1000	9
1370	6 X 3 X 18	1000	11
1375	6 X 4 X 15	1000	10
1374	6 X 4 X 20	1000	13
1380	8 X 3 X 15	1000	11
1385	8 X 3 X 20	1000	14
1390	8 X 4 X 15	1000	12
1395	8 X 4 X 18	1000	14
1393	10 X 4 X 20	1000	18
1396	10 X 6 X 20	1000	20
1398*	10 X 8 X 24	1000	27

1.25 MIL GUSSETED

ITEM	WxDxL	CNT	WT
1399*	20 X 18 X 30	250	22

1.5 MIL GUSSETED

ITEM	WxDxL	CNT	WT
1400	4 X 2 X 8	1000	5
1405	4 X 2 X 12	1000	7
1415	5 X 3 X 15	1000	12
1417	6 X 3 X 12	1000	10
1420	6 X 3 X 15	1000	13
1430	6 X 4 X 15	1000	14
1432	6 X 4 X 20	1000	18
1445*	8 X 4 X 15	1000	16
1450*	8 X 4 X 18	1000	20
1455*	10 X 4 X 20	1000	25
1465*	10 X 8 X 20	1000	32
1470*	10 X 8 X 24	1000	39
1475*	12 X 8 X 24	500	22
1480*	12 X 8 X 30	500	27
1482*	12 X 10 X 24	500	24
1486*	12 X 12 X 24	500	26

1.5 MIL GUSSETED

ITEM	WxDxL	CNT	WT
1493*	14 X 14 X 26	500	33
1485*	15 X 9 X 24	500	26
1496*	15 X 9 X 27	500	29
1490*	15 X 9 X 32	500	34
1491*	16 X 12 X 30	500	37
1497*	16 X 14 X 24	500	32
1498*	16 X 14 X 30	500	40
1495*	16 X 14 X 36	250	24
1499*	18 X 14 X 36	250	26
1500*	18 X 16 X 40	250	30
1508*	20 X 18 X 36	250	31
1505*	20 X 20 X 48	250	43
1503*	24 X 12 X 36	250	29
1510*	24 X 20 X 48	200	38
1515*	24 X 24 X 48	100	21
1516*	25 X 15 X 30	250	27
1517*	26 X 24 X 48	200	43
1518*	26 X 24 X 60	100	27
1520*	28 X 24 X 60	100	28
1514*	30 X 18 X 48	200	41
1525*	30 X 26 X 60	100	30

2 MIL GUSSETED

ITEM	WxDxL	CNT	WT
1530	4 X 2 X 8	1000	7
1533	4 X 2 X 10	1000	8
1535	4 X 2 X 12	1000	9
1540	5 X 2 X 12	1000	11
1545	5 X 3 X 15	1000	15
1547	6 X 3 X 12	1000	14
1550	6 X 3 X 15	1000	17
1555	6 X 3 X 18	1000	20
1560*	6 X 4 X 15	1000	18
1562*	6 X 4 X 20	1000	24
1565*	8 X 3 X 15	1000	20
1575*	8 X 4 X 15	1000	22
1580*	8 X 4 X 18	1000	26
1582*	8 X 4 X 22	1000	32
1585*	10 X 4 X 20	1000	34
1589*	10 X 6 X 20	1000	39
1590*	10 X 6 X 24	500	24
1595*	10 X 8 X 20	500	22
1600*	10 X 8 X 24	500	26

2 MIL GUSSETED

ITEM	WxDxL	CNT	WT
1605*	12 X 8 X 24	500	29
1610*	12 X 8 X 30	500	36
1611*	12 X 10 X 24	500	32
1612*	12 X 10 X 30	500	40
1613*	12 X 12 X 24	500	35
1621*	14 X 14 X 26	500	44
1615*	15 X 9 X 24	500	35
1620*	15 X 9 X 32	250	24
1617*	16 X 10 X 32	250	25
1618*	16 X 12 X 30	250	25
1619*	16 X 12 X 36	250	31
1623*	16 X 14 X 24	500	43
1624*	16 X 14 X 30	250	27
1625*	16 X 14 X 36	250	33
1627*	18 X 14 X 36	250	35
1630*	18 X 16 X 40	200	33
1622*	20 X 10 X 36	250	33
1636*	20 X 16 X 42	200	36
1637*	20 X 16 X 60	100	26
1638*	20 X 18 X 36	250	41
1635*	20 X 20 X 48	100	24
1629*	24 X 10 X 48	200	39
1632*	24 X 12 X 36	250	39
1640*	24 X 20 X 48	100	26
1645*	24 X 24 X 48	100	28
1647*	26 X 24 X 48	100	29
1648*	26 X 24 X 60	100	36
1649*	28 X 24 X 52	100	33
1650*	28 X 24 X 60	100	38
1646*	30 X 18 X 48	100	28
1655*	30 X 26 X 60	100	40

3 MIL GUSSETED

ITEM	WxDxL	CNT	WT
1665	4 X 2 X 12	1000	14
1675	5 X 3 X 15	1000	22
1680*	6 X 3 X 15	1000	25
1695*	8 X 3 X 15	1000	30
1705*	8 X 4 X 15	1000	32
1710*	8 X 4 X 18	1000	39
1712*	8 X 4 X 22	500	24
1715*	10 X 4 X 20	500	25
1717*	10 X 4 X 24	500	30

3 MIL GUSSETED

ITEM	WxDxL	CNT	WT
1719*	10 X 6 X 20	500	29
1725*	10 X 8 X 20	500	32
1730*	10 X 8 X 24	500	38
1735*	12 X 8 X 24	500	43
1740*	12 X 8 X 30	250	27
1738*	12 X 10 X 24	250	24
1739*	12 X 10 X 30	250	30
1742*	12 X 12 X 24	250	26
1743*	12 X 12 X 30	250	32
1749*	14 X 14 X 26	250	33
1745*	15 X 9 X 24	250	26
1750*	15 X 9 X 32	250	34
1746*	16 X 10 X 32	250	37
1747*	16 X 12 X 30	250	38
1753*	16 X 14 X 24	250	32
1754*	16 X 14 X 30	250	40
1755*	16 X 14 X 36	200	39
1756*	18 X 14 X 36	200	41
1760*	18 X 16 X 40	100	25
1751*	20 X 10 X 36	200	39
1762*	20 X 16 X 42	100	27
1764*	20 X 18 X 36	100	25
1765*	20 X 20 X 48	100	34
3296*	22 X 16 X 60	100	41
3281*	23 X 10 X 40	100	24
1757*	24 X 10 X 36	200	44
1758*	24 X 10 X 48	100	29
1759*	24 X 12 X 36	100	23
1770*	24 X 20 X 48	100	38
1775*	24 X 24 X 48	50	21
3287*	25 X 17 X 48	100	36
1776*	26 X 24 X 48	50	22
1777*	26 X 24 X 60	50	27
1774*	30 X 18 X 48	50	21
1785*	30 X 26 X 60	50	30

4 MIL GUSSETED

ITEM	WxDxL	CNT	WT
3276*	16 X 14 X 36	100	26
3282*	23 X 10 X 40	100	32
3289*	25 X 17 X 48	50	25

CONTACT US FOR MORE INFORMATION

ALTA-PAK MIDWEST
3401 NORTH JACKSON AVE
KANSAS CITY, MO 64117

TO REORDER CALL 816-453-7204

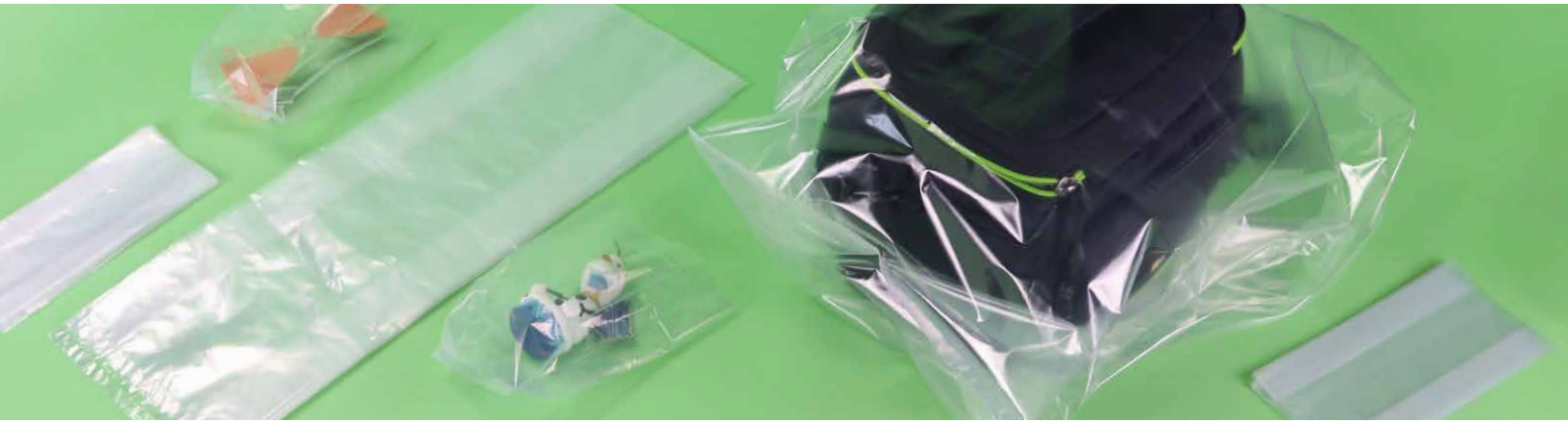

GUSSETED BAGS ON ROLLS

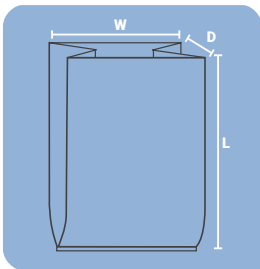

THE BASICS

Our Gusseted Bags on Rolls are designed with a tear perforation for easy dispensing and hand product loading. These are suitable for a wide range of applications and are ideal for large or bulky items.

TECHNICAL DETAILS

Made from 100% virgin Low-Density Polyethylene (LDPE) that meets FDA/USDA specifications. These are heat sealable and feature a bottom seal construction.



ENGINEERED AND MANUFACTURED IN THE U.S.A.

1 MIL GUSSETED

ITEM	WxDxL	CNT	WT
1395R*	8 X 4 X 18	1000	14
1398R*	10 X 8 X 24	1000	28
1400R*	48 X 42 X 48	150	43

1.25 MIL GUSSETED

ITEM	WxDxL	CNT	WT
975*	54 X 44 X 96	100	78

1.5 MIL GUSSETED

ITEM	WxDxL	CNT	WT
1485R*	15 X 9 X 24	500	27
1495R*	16 X 14 X 36	250	25
1508R*	20 X 18 X 36	250	32
1510R*	24 X 20 X 48	200	39
1515R*	24 X 24 X 48	100	22
1517R*	26 X 24 X 48	200	44
1525R*	30 X 26 X 60	100	32
10000*	32 X 28 X 48	200	53
10010*	32 X 28 X 72	135	54
10045*	36 X 28 X 60	160	57
10095*	36 X 36 X 60	130	53
10110*	42 X 32 X 54	140	53
10115*	42 X 32 X 60	130	54
10160*	44 X 36 X 80	100	60
10170*	44 X 36 X 96	80	58
10195*	46 X 44 X 80	70	48
10180*	48 X 36 X 72	110	63
10210*	48 X 46 X 72	75	48
10215*	48 X 46 X 96	60	51
10240*	51 X 49 X 73	75	52
10242*	51 X 49 X 85	60	49
10245*	51 X 49 X 97	50	47
10250*	52 X 48 X 96	60	55
10255*	52 X 48 X 108	50	51
10225*	53 X 42 X 78	65	46
10230*	54 X 44 X 72	75	51
10235*	54 X 44 X 96	60	54
10265*	58 X 46 X 96	60	57
10270*	58 X 46 X 108	50	54

2 MIL GUSSETED

ITEM	WxDxL	CNT	WT
1580R*	8 X 4 X 18	1000	27
1600R*	10 X 8 X 24	500	27
1605R*	12 X 8 X 24	500	30
1625R*	16 X 14 X 36	250	33
1638R*	20 X 18 X 36	250	42
1639R*	23 X 17 X 46	200	46
1640R*	24 X 20 X 48	100	27
1655R*	30 X 26 X 60	100	42
10300*	32 X 28 X 48	160	57
10305*	32 X 28 X 60	130	58
10310*	32 X 28 X 72	110	59
10315*	32 X 28 X 84	90	56
10320*	32 X 28 X 96	80	57
10345*	36 X 28 X 60	130	62
10370*	36 X 32 X 48	160	65
10375*	36 X 32 X 60	130	66
10390*	36 X 36 X 48	125	54
10400*	36 X 36 X 72	80	52
10410*	42 X 32 X 54	110	55
10415*	42 X 32 X 60	100	56
10420*	42 X 32 X 72	80	54
10425*	42 X 32 X 84	70	55
10460*	44 X 36 X 80	75	61
10465*	44 X 36 X 88	70	62
10470*	44 X 36 X 96	60	58
10475*	44 X 36 X 108	55	60
10495*	46 X 44 X 80	55	51
10500*	46 X 44 X 100	45	52
10435*	48 X 30 X 60	100	59
10440*	48 X 30 X 72	80	57
10480*	48 X 36 X 72	80	61
10485*	48 X 36 X 96	60	61
10490*	48 X 42 X 48	100	57
10510*	48 X 46 X 72	60	52
10515*	48 X 46 X 96	45	52
10520*	48 X 46 X 126	35	53
10522*	51 X 49 X 73	55	51
10523*	51 X 49 X 85	50	54
10524*	51 X 49 X 97	40	50

2 MIL GUSSETED

ITEM	WxDxL	CNT	WT
10550*	52 X 48 X 96	45	55
10555*	52 X 48 X 108	40	55
10525*	53 X 42 X 78	55	52
10530*	54 X 44 X 72	60	54
10535*	54 X 44 X 96	45	54
10545*	54 X 44 X 132	30	50
10565*	58 X 46 X 96	45	58
10575*	58 X 46 X 125	35	58
10580*	68 X 65 X 82	50	70

3 MIL GUSSETED

ITEM	WxDxL	CNT	WT
1755R*	16 X 14 X 36	200	40
1764R*	20 X 18 X 36	100	26
1775R*	24 X 24 X 48	50	22
1776R*	26 X 24 X 48	50	23
1785R*	30 X 26 X 60	50	32
1800R*	48 X 46 X 72	45	57
1815R*	51 X 49 X 85	35	56
1817R*	51 X 49 X 97	30	52
1825R*	54 X 44 X 72	40	54
1820R*	54 X 44 X 96	30	54

4 MIL GUSSETED

ITEM	WxDxL	CNT	WT
10600*	32 X 28 X 48	80	57
10605*	32 X 28 X 60	65	58
10610*	32 X 28 X 72	55	59
10615*	32 X 28 X 84	45	56
10620*	32 X 28 X 96	40	57
10645*	36 X 28 X 60	65	62
10655*	36 X 28 X 96	40	61
10670*	36 X 32 X 48	80	65
10675*	36 X 32 X 60	65	66
10690*	36 X 36 X 48	60	52
10695*	36 X 36 X 60	50	54
10700*	36 X 36 X 72	40	52
10705*	36 X 36 X 108	25	49
10630*	40 X 22 X 72	55	62

4 MIL GUSSETED

ITEM	WxDxL	CNT	WT
10710*	42 X 32 X 54	55	55
10715*	42 X 32 X 60	50	56
10720*	42 X 32 X 72	40	54
10725*	42 X 32 X 84	35	55
10790*	44 X 36 X 80	35	57
10760*	44 X 36 X 88	35	62
10770*	44 X 36 X 108	25	55
10772*	44 X 44 X 70	25	40
10795*	46 X 44 X 80	35	63
10800*	46 X 44 X 100	30	68
10735*	48 X 30 X 60	50	59
10775*	48 X 36 X 72	40	61
10810*	48 X 46 X 72	35	60
10815*	48 X 46 X 96	25	57
10817*	50 X 44 X 57	25	36
10819*	50 X 48 X 84	25	53
10818*	51 X 49 X 73	30	56
10820*	51 X 49 X 85	25	54
10821*	51 X 49 X 97	20	50
10822*	52 X 43 X 70	25	43
10850*	52 X 48 X 96	25	61
10860*	52 X 48 X 120	20	61
10825*	53 X 42 X 78	35	66
10830*	54 X 44 X 72	30	54
10835*	54 X 44 X 96	25	60
10840*	54 X 44 X 120	20	60
10845*	54 X 44 X 132	20	65
10865*	58 X 46 X 96	25	64
10875*	58 X 46 X 125	20	66
10878*	68 X 65 X 82	25	70

CONTACT US FOR MORE INFORMATION

ALTA-PAK MIDWEST
3401 NORTH JACKSON AVE
KANSAS CITY, MO 64117

TO REORDER CALL 816-453-7204



SUFFOCATION WARNING BAGS

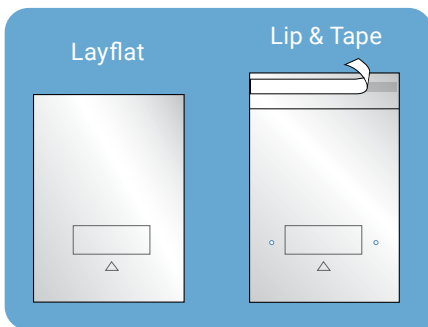

THE BASICS

Our Suffocation Warning Bags are perfect for mail-order and shipping applications. These are printed with a standard 3-language suffocation warning with a recycling symbol to meet the standard shipping requirements of many online retailers.

TECHNICAL DETAILS

Made from 100% virgin Low-Density Polyethylene. All layflat bags are heat sealable and feature a bottom seal construction. Lip and tape bags feature a resealable tape closure and side weld construction. Available in cases.

PRINTED LAYFLAT BAGS

- ▶ 14 popular stock sizes, available for same-day shipping.
- ▶ The suffocation warning is printed in the size required for each bag size in 10pt, 14pt, or 18pt text.

1 MIL LAYFLAT PRINTED BAGS

ITEM	W x L	TEXT	CNT	WT
16050	9 x 12	10pt	1000	7
16053	10 x 15	10pt	1000	9
16055	12 x 18	14pt	1000	13
16060	18 x 24	18pt	1000	26

2 MIL LAYFLAT PRINTED BAGS

16100	6 X 9	10pt	1000	7
16105	8 X 10	10pt	1000	11
16110	9 X 12	10pt	1000	14
16115	10 X 15	10pt	1000	20
16120	11 X 14	10pt	1000	21
16125	12 X 18	14pt	1000	29
16130	14 X 20	14pt	1000	37
16135	18 X 24	18pt	500	29
16140	18 X 30	18pt	500	36
16145	22 X 24	18pt	500	35

DON'T SEE WHAT YOU NEED?

No problem! It's quick and easy to build your own bag. Just call your Rep today to walk you through it.

PRINTED RESEALABLE LIP & TAPE BAGS

- ▶ 18 popular stock sizes, available for same-day shipping.
- ▶ 1.5 mil with 1.5 inch lip.
- ▶ The suffocation warning is printed in the size required for each bag in 10pt, 14pt, or 18pt text.

1.5 MIL LIP & TAPE BAGS

ITEM	W x L	TEXT	CNT	WT
16200	6 x 6	10pt	1000	5
16205	6 x 9	10pt	1000	7
16210	8 x 10	10pt	1000	9
16215	9 x 12	10pt	1000	12
16218	10 x 12	10pt	1000	12
16220	10 x 15	10pt	1000	17
16225	11 x 14	10pt	1000	17
16228	12 x 15	10pt	1000	18
16230	12 x 18	14pt	1000	24
16235	14 x 20	14pt	1000	30
16238	16 x 20	14pt	500	15
16240	16 x 24	18pt	500	21
16242	18 x 24	18pt	500	21
16245	22 x 24	18pt	500	28

1.5 MIL VENTED* BAGS

16260	9 x 12	10pt	1000	11
16265	10 x 15	10pt	1000	15
16270	12 x 18	14pt	1000	21
16275	16 x 24	18pt	500	19

*2 Standard Vent Holes, 1 on either side of the Suffocation Warning.

CONTACT US FOR
MORE INFORMATION

ALTA-PAK MIDWEST
3401 NORTH JACKSON AVE
KANSAS CITY, MO 64117

TO REORDER CALL 816-453-7204

PRE-OPENED BAGS ON ROLLS

FOR AUTOMATED PACKAGING EQUIPMENT

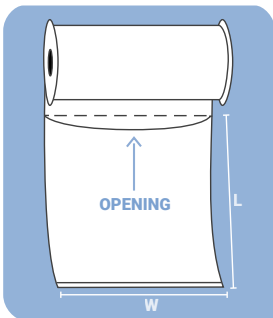

THE BASICS

Our Pre-Opened Bags on Rolls are designed for quick automatic or hand loading of a variety of products. These are constructed with a slit in front and a perforated back and can be easily sealed or detached. Bags over 12" in length have vent holes and are marked with an asterisk.

TECHNICAL DETAILS

Made from 100% virgin Low-Density Polyethylene. These are heat sealable and feature a side weld and bottom seal construction.

1.5 MIL CLEAR

ITEM	W x L	CNT	WT
2600	3 X 3	4500	6
2612	3 X 4	4000	7
2613	3 X 5	3000	5
2614	3 X 6	2500	6
2633	4 X 4	4000	9
2634	4 X 5	3000	8
2635	4 X 6	2500	8
2663	5 X 7	2000	9
2684	6 X 6	2500	11
2685	6 X 8	1750	11
2686	6 X 9	1500	10
2710	8 X 10	1500	14
2723	9 X 12*	1250	16

2 MIL CLEAR

ITEM	W x L	CNT	WT
2595	2 X 3	4000	5
2605	3 X 3	4000	6
2610	3 X 4	3000	6
2615	3 X 5	2000	5
2617	3 X 6	2000	6
2619	3 X 8	1250	5
2620	4 X 4	3000	8
2630	4 X 5	2000	7
2640	4 X 6	2000	7
2642	4 X 8	1250	6
2644	5 X 5	2250	9
2655	5 X 6	2000	9
2665	5 X 7	1750	9
2667	5 X 8	1250	8
2677	5 X 10	1250	9
2678	5 X 12*	1000	9
2680	6 X 6	2000	11
2690	6 X 8	1250	9
2703	6 X 10	1250	11
2705	6 X 12*	1000	11
2707	7 X 8	1250	10
2715	8 X 10	1250	14
2724	8 X 12*	1000	14
2725	9 X 12.5*	1000	16
2730	10 X 12*	1000	17
2733	10 X 15*	750	16

BUILD ANY SIZE:
Mil: 1.5-4 Width: 2"-20" Length: 2"-36"
MORE OPTIONS:
Film Color, Printing, Venting.

3 MIL CLEAR

ITEM	W x L	CNT	WT
2624	3 X 5	1500	2
2625	4 X 4	2000	7
2626	4 X 5	1500	7
2645	4 X 6	1500	8
2670	5 X 7	1250	9
2695	6 X 8	1000	11
2720	8 X 10	750	13
2727	9 X 12*	750	17

4 MIL CLEAR

ITEM	W x L	CNT	WT
2650	4 X 6	1000	8
2675	5 X 7	1000	10
2700	6 X 8	750	11
2722	8 X 10	500	12
2729	9 X 12*	500	15
2732	9 X 12.5*	500	16



2 MIL WHITE FRONT/CLEAR BACK

ITEM	W x L	CNT	WT
2525	3 X 5	2000	5
2530	4 X 6	2000	7
2535	5 X 7	1750	10
2540	6 X 8	1250	10
2545	8 X 10	1250	14
2547	9 X 12.5*	1000	15

BUILD ANY SIZE:
Mil: 1.5-4 Width: 2"-20" Length: 2"-36"
MORE OPTIONS:
Film Color, Printing, Venting.

CONTACT US FOR
MORE INFORMATION

ALTA-PAK MIDWEST
3401 NORTH JACKSON AVE
KANSAS CITY, MO 64117

TO REORDER CALL 816-453-7204

SPECIALTY RETAIL BAGS

THE BASICS

Our specialty bags are designed for retail and carryout applications. Lightweight and durable, these are available in a variety of constructions with different handle styles.

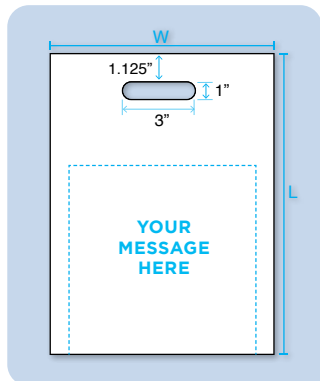

LOW-DENSITY MERCHANDISE BAGS

Our LDPE Merchandise bags are designed with a standard racetrack die cut handle for carryout applications. Choose from 3 stock sizes in 2 mil in clear or white film. Printed options are available.

PRODUCT FEATURES

- ▶ Print up to 8 colors on 2 sides
- ▶ Spot and process printing

TECHNICAL DETAILS

Made from a blend of 100% virgin Low and Linear Low-Density Polyethylene in 2 mil. These are equipped with a 3" racetrack die cut handle and feature a side weld construction. Packaged in cases.

ITEM	W x L	CNT	WT
CLEAR			
6685	9 X 12	1000	15
6687	12 X 15	1000	26
6689	15 X 18	1000	37
WHITE			
6690	9 X 12	1000	15
6693	12 X 15	1000	26
6695	15 X 18	1000	37



LOW-DENSITY MERCHANDISE BAGS WITH 25% PCR

Our LDPE Merchandise Bags with 25% PCR are designed with a portion of Post-Consumer Recycled material, such as bottles from curbside bins, to keep waste out of landfills. Available in 4 sizes in 2.25 mil with a racetrack die cut handle in white film.

PRODUCT FEATURES

- ▶ Print up to 8 colors on 2 sides
- ▶ Spot and process printing
- ▶ 18" x 19" size has patch handle

TECHNICAL DETAILS

Made from a blend of 100% virgin Low and Linear Low-Density Polyethylene and 25% Post-Consumer Recycled Material (PCR) in 2.25 mil. These are equipped with a 3" racetrack die cut or reinforced patch handle and feature a side weld construction. Printed with a standard recycled message. Packaged in cases.

ITEM	W x L	CNT	WT
NO GUSSET			
6725	9 X 12	1000	17
6727	12 X 15	1000	27
4" BOTTOM GUSSET			
6730	15 X 19	500	24
6735*	18 X 19	500	29

* Item 6735 has a Patch handle.

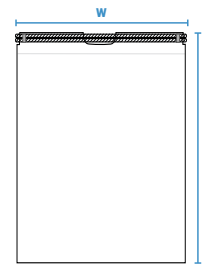

DRAWSTRING BAGS

Our Drawstring Bags are designed with a single white cotton string closure that can be pulled tight and used as a handle for carryout applications. Available in a range of sizes, thicknesses, film colors and tints with custom printing.

TECHNICAL DETAILS

Made from 100% virgin Low-Density Polyethylene. These feature a side weld construction and have a 2" fold over for the string to run through with semi-circles punched out of the film for it to be grasped. Packaged in cases.

BUILD ANY SIZE: Mil: 1.25-2.5
Width: 8"-18" Length: 13"-34"
MORE OPTIONS:
Film Color, Printing

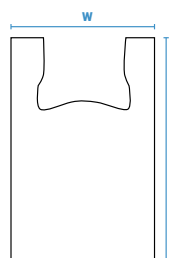

PRINTED T-SHIRT BAGS

Our Printed T-Shirt Bags are available in the industry's most popular size in white film. These are commonly referred to as "Thank You" bags.

TECHNICAL DETAILS

Made from 100% virgin High-Density Polyethylene. All bags have 6" loop handles and standard mounting holes to be hung on a rack. These feature a bottom seal and a 6.5" side gusset for bag expansion. Packaged in cases.

CUSTOM PRINTED BAGS WITH 6" HANDLE

W x L	CNT	WT
14 MICRONS - 6.5" SIDE GUSSET		
11.5 X 22	1000	13

CLEAN ROOM CLASS 100 BAGS

Our Clean Room Bags are manufactured in an environment that is free from contaminants. These meet the performance parameters as outlined in ISO 14644-1 for an ISO Class 5 clean room at 0.5 microns Available in a variety of sizes and gauges.

TECHNICAL DETAILS

Made from 100% virgin Low-Density Polyethylene. All bags are heat sealable and feature a bottom seal construction. Packaged in cases.



CONTACT US FOR MORE INFORMATION

ALTA-PAK MIDWEST
3401 NORTH JACKSON AVE
KANSAS CITY, MO 64117

TO REORDER CALL 816-453-7204

SPECIALTY BAGS

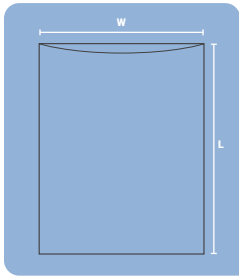

MULCH BAGS

Our Mulch Bags are designed to contain a variety of landscaping materials, such as soil, bark mulch, vermiculite, nursery blends and more. These bags exhibit additional puncture and UV resistance to withstand the effects of weathering and rough handling.

PRODUCT FEATURES

- ▶ Six of the most popular sizes and constructions
- ▶ Clear or white film
- ▶ Strong 3.5 mil LDPE with Low-Slip for increased puncture resistance to withstand weathering and rough handling
- ▶ One year UVI prevents damage that could be incurred from the sun's harmful UV rays
- ▶ Standardized venting patterns are available to prevent moisture buildup and mold
- ▶ 100% recyclable at your local drop off center

TECHNICAL DETAILS

Made with 100% Low-Density Polyethylene with UVI and Low-Slip. All bags are heat sealable and feature a side weld construction. Packaged in cases.

CUSTOM MULCH BAG OPTIONS

W x L	COVERAGE	WT. CAPACITY
14 X 22	0.5 cu/ft	15–20 lbs.
16 X 24	0.5 cu/ft	15–20 lbs.
18 X 25	0.75 cu/ft	22–25 lbs.
20 X 26	1 cu/ft	36–40 lbs.
22 X 29	1.5 cu/ft	55 lbs.
24 X 36	2 cu/ft	65–75 lbs.

MORE OPTIONS: **Printing up to 8 colors, Venting**



GARMENT BAGS

Our Garment Bags are ideal for cleaners and clothing storage and serve as a barrier from moisture and damaging debris. These are lightweight and perforated on a roll for easy and quick dispensing. Available printed with a standard 3-language suffocation warning.

TECHNICAL DETAILS

Made from 100% virgin Low-Density Polyethylene in 0.6 mil. These have sloped shoulders and slit holes for hangers. All bags are available on rolls with 3" cores.

ITEM	W x D x L	CNT	WT
8009	21 x 4 x 30	650	23
8010	21 x 4 x 38	510	23
8012	21 x 4 x 54	360	23
8014	21 x 4 x 72	270	23

BUILD ANY SIZE: **Mil: 0.6–1**
Width: 23"–29" Length: 28"–72"



HIGH-DENSITY BAGS

Our High-Density Bags are FDA approved for food use. HDPE offers enhanced moisture barrier properties, making it an ideal choice for food items, such as baked goods and produce, or lightweight trash.

TECHNICAL DETAILS

Made from 100% virgin High-Density Polyethylene. All bags are heat sealable and feature a bottom seal construction. Available in cases or on rolls with 3" cores.

BUILD ANY SIZE: **Microns: 10–25.4**
Width: 9"–45" Depth: 4"–22" Length: 10"–60"
MORE OPTIONS: **Film Color, Venting, Packaging Details**



DOORKNOB BAGS

Our Doorknob Bags offer visibility and protection for marketing adverts, samples and other promotional materials. These bags are designed with a 1.5" standard hang hole and serve as a barrier from weathering and other damaging debris. Available mounted on a cardboard header for rapid loading.

TECHNICAL DETAILS

Made from 100% virgin Low-Density Polyethylene. These feature a side weld construction and are available packaged 1,000 per case with 100 bags per header.

ITEM	W x L	CNT	WT
1.5 MIL WITH 3.5" LIP			
5015	6 X 12	1000	10
5020	10 X 15	1000	18

CONTACT US FOR MORE INFORMATION

ALTA-PAK MIDWEST
3401 NORTH JACKSON AVE
KANSAS CITY, MO 64117

TO REORDER CALL 816-453-7204

SPECIALTY BAGS

MATTRESS BAGS ON ROLLS

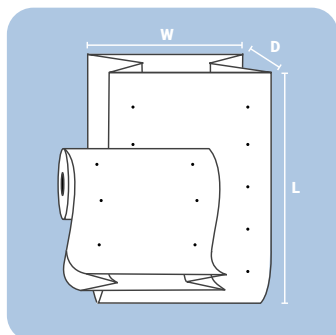

Our Mattress Bags are an ideal protective covering during transportation and in storage, serving as a barrier from moisture, dust and other damaging debris. Expanded for deeper pillow top mattresses up to 18 and vented for quick loading.

TECHNICAL DETAILS

Made from a blend of 100% virgin Low and Linear Low-Density Polyethylene with Non-Slip. These have butterfly vents on both sides 3" from the side, 10" up from the bottom, and 10" between each hole. All bags feature a side weld construction and are available perforated on rolls with a 3" core plugs and 1" diameter holes.



MATTRESS BAGS

ITEM	W x D x L	SIZE	CNT	WT
1.5 MIL STANDARD				
3220*	39 X 8 X 90	Twin	100	41
3222*	54 X 8 X 90	Full	100	54
3 MIL STANDARD				
3242*	39 X 9 X 90	Twin	75	61
3244*	54 X 9 X 90	Full	60	64
3246*	60 X 9 X 90	Queen	55	65
3247*	60 X 12 X 90	X-Queen	55	68
3248*	78 X 9 X 90	King	45	68
3249*	78 X 12 X 90	X-King	45	71
3 MIL PILLOW TOP				
3110*	40 X 15 X 95	Twin	55	54
3115*	56 X 15 X 95	Full	45	58
3118*	62 X 15 X 95	Queen	40	56
3120*	62 X 18 X 95	X-Queen	40	58
3125*	82 X 15 X 100	King	35	66
3127*	82 X 18 X 100	X-King	35	68
4 MIL STANDARD				
3250*	39 X 9 X 90	Twin	50	55
3253*	54 X 9 X 90	Full	45	65
3255*	60 X 9 X 90	Queen	40	64
3262*	60 X 12 X 90	X-Queen	40	66
3260*	78 X 9 X 90	King	30	62
3264*	78 X 12 X 90	X-King	30	64
4 MIL PILLOW TOP				
3130*	40 X 15 X 95	Twin	50	65
3132*	56 X 15 X 95	Full	40	69
3135*	62 X 15 X 95	Queen	35	65
3137*	62 X 18 X 95	X-Queen	35	68
3138*	82 X 15 X 100	King	25	64
3140*	82 X 18 X 100	X-King	25	66

Toddler crib mattress bags can be custom ordered.

BUILD ANY SIZE: Mil: 1-6 Width: 47"-120" Length: 50"-120"
MORE OPTIONS: Materials, Film Color, Printing, Venting, Packaging Details

FURNITURE COVERS ON ROLLS

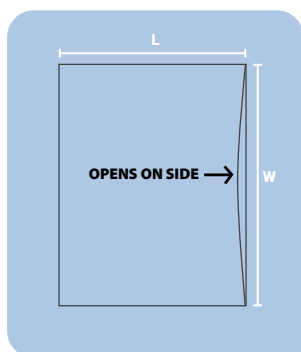

Our Furniture Covers are durably designed to fit the most common sized sofas and arm chairs and provide protections from dirt, stains and dust.

- ▶ Ideal for movers, retailers and manufacturers
- ▶ Clear covers are perforated on rolls for fast and easy dispensing
- ▶ Open along the width as shown

TECHNICAL DETAILS

Made from 100% virgin Low-Density Polyethylene. These feature a side weld construction. All bags are available on rolls with a 3" core plug and 1" diameter hole.



BUILD ANY SIZE: Mil: 1-6 Width: 25"-1200" Length: 24"-98"
MORE OPTIONS: Materials, Film Color, Printing, Venting, Packaging Details

FURNITURE COVERS

ITEM	W x L	SIZE	CNT	WT
1 MIL				
3160*	50 X 45	26" Chair	300	49
3165*	54 X 45	29" Chair	275	49
3170*	70 X 45	36" Chair	215	50
3175*	76 X 45	42" Chair	200	50
3180*	84 X 45	50" Chair	175	48
3185*	90 X 45	56" Chair	165	49
3190*	92 X 45	60" Chair	160	49
3195*	106 X 45	70" Loveseat	140	49
3200*	124 X 45	90" Sofa	125	51
3205*	134 X 45	100" Sofa	110	49
3210*	140 X 45	106" Sofa	100	46
3215*	152 X 45	116" Sofa	100	50
3 MIL				
3212	54 X 45	29" Chair	100	44
3214	90 X 45	56" Chair	55	41
3216	106 X 45	70" Loveseat	50	44
3217	124 X 45	90" Sofa	40	41
3218	140 X 45	106" Sofa	35	40
3219	152 X 45	116" Sofa	35	44

CONTACT US FOR MORE INFORMATION

ALTA-PAK MIDWEST
 3401 NORTH JACKSON AVE
 KANSAS CITY, MO 64117

TO REORDER CALL 816-453-7204



STATIC CONTROL

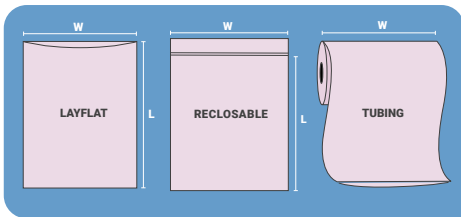

PINK ANTI-STATIC (PAS) BAGS & TUBING

Our Pink Anti-static Bags & Tubing are designed to prevent the buildup of static electricity and protect non-static sensitive parts used in electronics (e.g., nuts, bolts, etc...) during transportation and in storage.

PRODUCT FEATURES

- ▶ Amine-Free
- ▶ Won't corrode polycarbonate surfaces and functions in low relative humidity.
- ▶ Film has a Surface Resistivity of less than 1×10^{12} ohms/sq.
- ▶ 4 mil products meet the full Static Decay Requirements of MIL-PRF-81705E, Type II and EIA-541.
- ▶ Layflat Bags and Tubing are heat sealable.
- ▶ Tubing gives you the freedom to bag your sensitive electrical components for an exact fit.

TECHNICAL DETAILS

Made from 100% virgin Low-Density Polyethylene with an amine-free anti-static additive. All Layflat Bags feature a bottom seal and Reclosable Bags feature a side weld construction. All bags are available in cases. Tubing is packaged on rolls with 3" cores.

Pink Anti-Static Layflat Bags

ITEM	W x L	CNT	WT
2 MIL			
12005	3 X 5	1000	3
12010*	4 X 6	1000	4
12020*	6 X 8	1000	7
12025*	6 X 10	1000	8
12035*	9 X 12	1000	15
12040*	10 X 16	1000	22
12045*	12 X 15	1000	25
12050*	12 X 18	1000	30
12055*	18 X 24	500	30
4 MIL			
12110*	4 X 6	1000	7
12130*	6 X 8	1000	13
12140*	6 X 10	1000	16
12150*	8 X 10	1000	22
12160*	9 X 12	1000	30
12165*	10 X 12	1000	33
12172*	10 X 16	1000	44
12175*	12 X 15	500	25
12185*	12 X 18	500	30
12190*	12 X 24	500	39
12195*	14 X 18	500	35
12202*	16 X 20	500	44
12210*	18 X 24	250	30
12215*	20 X 24	250	33
12220*	24 X 30	250	49
12225*	24 X 36	100	24
12230*	36 X 36	100	36
12235*	36 X 42	100	42
12240*	36 X 48	50	24

BUILD ANY SIZE:
Mil: 1-8 Width: 3"-98" Length: 5"-288"
 MORE OPTIONS:
Printing, Venting, Packaging Details

Pink Anti-Static Reclosable Bags

ITEM	W x L	CNT	WT
4 MIL			
4022	2.5 X 3	1000	4
4025	3 X 5	1000	6
4030	4 X 6	1000	9
4035	6 X 8	1000	17
4040	8 X 10	1000	27
4045	9 X 12	1000	35
4050	12 X 12	500	23
4055	13 X 18	500	36

BUILD ANY SIZE:
Mil: 1.5-6 Width: 2.5"-30" Length: 3"-36"
 MORE OPTIONS:
Printing, Venting, Packaging Details

Pink Anti-Static Tubing

ITEM	WIDTH	FT/RL	WT
4 MIL - 3" CORE			
12515*	10"	750	26
12520*	12"	750	30
12545*	24"	750	60
12550*	32"	500	55

BUILD ANY SIZE:
Mil: 0.75-8 Width: 4"-98"
 MORE OPTIONS:
Printing, Venting, Packaging Details

***smart tech bags®**

ENGINEERED AND MANUFACTURED
 IN THE U.S.A. BY LADDAWN

CONTACT US FOR
 MORE INFORMATION

ALTA-PAK MIDWEST
 3401 NORTH JACKSON AVE
 KANSAS CITY, MO 64117

TO REORDER CALL 816-453-7204

STATIC CONTROL

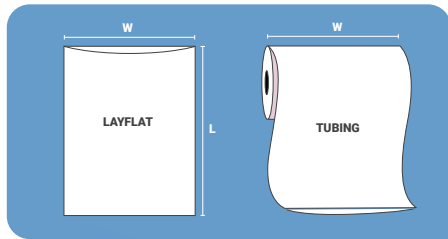

TECHNICAL DETAILS

Made from a blend of 100% virgin Low and Linear Low-Density Polyethylene with a conductive additive. These meet the requirements of MIL-P-82646 Rev. B. All bags and tubing are heat sealable. Bags are packaged in cases and tubing comes on rolls.

BLACK CONDUCTIVE BAGS & TUBING

Our Black Conductive Bags & Tubing are designed for packaging static sensitive components where electrostatic contamination is a problem. These meet the requirements of MIL-P-82646 Rev.B.

Black Conductive Layflat Bags

ITEM	W x L	CNT	WT
4 MIL			
6505	4 X 6	100	1
6510	5 X 8	100	1
6520	6 X 10	100	2
6535	8 X 12	100	3
6550	12 X 16	100	6
6555	12 X 18	100	6
6560	14 X 18	100	7
6565	16 X 20	100	9
6570	18 X 24	100	12
6580	20 X 30	100	17
6590	24 X 36	100	24

Black Conductive Tubing

ITEM	WIDTH	FT/RL	WT
4 MIL			
5706	4"	750	14
5708	6"	750	21
5709	8"	750	28
5710	10"	750	35
5711	12"	750	40
5712	14"	750	47

BUILD ANY SIZE: Mil: 2-10 Width: 2"-60"
MORE OPTIONS: Packaging Details

BUILD ANY SIZE:
Mil: 2-10 Width: 2"-60" Length: 4"-60"

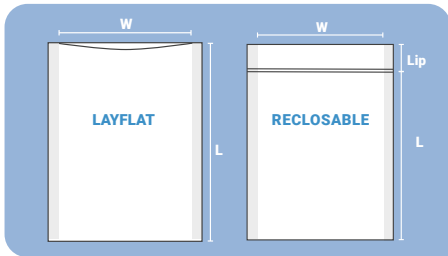

PRODUCT FEATURES

- ▶ Static shielding notice is stamped in yellow on bags
- ▶ Layflat bags are heat sealable
- ▶ Extended shelf life
- ▶ 100 per carton

TECHNICAL DETAILS

Made of Polyethylene, Polyester, and Aluminum Layers with an Anti-static Coating. Meet electrical and physical requirements of ANSI/ESD S541, EIA 625 and are ANSI/ESD S20.20 program compliant. Tested per MIL-STD-3010 4046 and ANSI/ESD STM11.11. All bags feature a side weld construction. Available in cases.

STATIC SHIELDING BAGS

Our Static Shielding Bags are designed with Faraday Cage protection and 60% visibility for highly sensitive components. This includes items that could be damaged by static in shipment or storage (e.g., circuit boards, hard drives, sound cards, etc.).

3 Mil Layflat Bags

ITEM	W x L	CNT	WT
4100	3 X 5	100	1
4105	4 X 6	100	1
4099	4 X 8	100	1
4101	5 X 7	100	1
4110	5 X 8	100	1
4115	6 X 8	100	2
4120	6 X 10	100	2
4102	6 X 12	100	2
4109	6 X 24	100	4
4124	8 X 10	100	2
4125	8 X 12	100	3
4114	8 X 14	100	3
4122	9 X 12	100	3
4130	10 X 12	100	3
4126	10 X 18	100	5
4137	10 X 24	100	5
4140	12 X 16	100	5
4141	12 X 18	100	5
4152	18 X 24	100	8

3 Mil Reclosable Bags

ITEM	W x L	CNT	WT
6300	2 X 3	100	1
4150	3 X 5	100	1
4151	4 X 6	100	1
4153	5 X 8	100	2
6325	6 X 8	100	2
4154	6 X 10	100	3
4155	8 X 10	100	3
4156	8 X 12	100	4
4157	10 X 12	100	4
6340	10 X 14	100	4
6355	12 X 16	100	5
6370	15 X 18	100	7
6385	18 X 24	100	11

BUILD ANY SIZE: Mil: 3 Width: 2"-30"
Length: 3"-36"
MORE OPTIONS: Packaging Details

BUILD ANY SIZE: Mil: 3 Width: 2"-30"
Length: 3"-36"
MORE OPTIONS: Packaging Details

CONTACT US FOR
 MORE INFORMATION

ALTA-PAK MIDWEST
 3401 NORTH JACKSON AVE
 KANSAS CITY, MO 64117

TO REORDER CALL 816-453-7204



RECLOSABLE BAGS

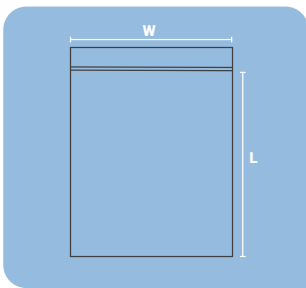

THE BASICS

Our Reclosable Bags are ideal for a variety of applications, including electronics, food service, and retail packaging. A durable zipper closure ensures that contents remain secure and allows for continued bag reuse.

TECHNICAL DETAILS

Made from 100% virgin Low-Density Polyethylene that meets FDA/USDA specifications. All bags feature a single-track zipper closure and side weld construction. Available in cases.

How Much Does It Hold?

Do you know how much you need to hold, but don't know which size to pick? Check out our easy reference guide to find a perfect fit.

Capacity	W x L	2 MIL	4 MIL
1 Quart	7 x 8	3626A	—
1/2 Gallon	8 x 10	3635A	3760A
1 Gallon	10 x 12	3655A	3775A
2 Gallons	13 x 15	3675A	3793A

RECLOSABLES

ITEM	W x L	CNT	WT
1 MIL RECLOSABLE SANDWICH BAG			
6682	6.5 X 6	500	3
2 MIL			
3515A	1.5 X 2	1000	1
3520A	2 X 2	1000	1
3525A	2 X 3	1000	2
3530A	2 X 5	1000	2
3535A	2 X 8	1000	3
3540A	3 X 3	1000	3
3545A	3 X 4	1000	3
3550A	3 X 5	1000	3
3555A	3 X 6	1000	4
3556A	3 X 8	1000	4
3560A	4 X 4	1000	5
3565A	4 X 6	1000	5
3570A	4 X 7	1000	6
3575A	4 X 8	1000	6
3578A	5 X 5	1000	5
3579A	5 X 6	1000	6
3580A	5 X 7	1000	7
3585A	5 X 8	1000	7
3590A	5 X 10	1000	9
3595A	5 X 12	1000	10
3600A	6 X 4	1000	5
3605A	6 X 6	1000	8
3610A	6 X 8	1000	9
3615A	6 X 9	1000	10
3620A	6 X 10	1000	11
3625A	6 X 12	1000	13
3626A	7 X 8	1000	10
3627A	7 X 9	1000	11
3628A	7 X 10	1000	12
3630A	8 X 8	1000	12
3635A	8 X 10	1000	14
3640A	8 X 12	1000	16
3645A	9 X 12	1000	18
3650A	10 X 10	1000	17
3655A	10 X 12	1000	20
3660A	10 X 13	1000	21
3665A	12 X 12	1000	23
3670A	12 X 15	1000	29
3672A	12 X 18	1000	31
3675A	13 X 15	1000	31

RECLOSABLES

ITEM	W x L	CNT	WT
3678A	13 X 18	1000	39
3676A	14 X 16	1000	38
3677A	14 X 20	500	21
3681A	16 X 18	1000	46
3679A	18 X 20	500	28
3680A	18 X 24	500	35
3682A	20 X 24	500	37
3 MIL			
4305A	4 X 6	1000	6
4310A	5 X 8	1000	10
4315A	6 X 8	1000	13
4320A	6 X 9	1000	14
4325A	8 X 10	1000	20
4330A	9 X 12	1000	27
4335A	10 X 12	1000	30
4340A	12 X 12	1000	35
4345A	12 X 15	1000	43
4350A	13 X 18	500	29
4 MIL			
3684A	2 X 3	1000	3
3685A	2.5 X 3	1000	4
3690A	3 X 3	1000	4
3695A	3 X 4	1000	5
3700A	3 X 5	1000	6
3705A	4 X 4	1000	7
3710A	4 X 6	1000	9
3712A	4 X 8	1000	12
3715A	4 X 10	1000	14
3720A	5 X 8	1000	14
3725A	5 X 12	1000	20
3728A	6 X 4	1000	8
3730A	6 X 6	1000	13
3735A	6 X 8	1000	17
3740A	6 X 9	1000	19
3745A	6 X 10	1000	19
3748A	6 X 15	1000	28
3750A	7 X 9	1000	21
3755A	8 X 8	1000	22
3760A	8 X 10	1000	26
3765A	9 X 12	1000	34
3770A	10 X 10	500	17
3775A	10 X 12	500	19
3780A	10 X 13	500	21

RECLOSABLES

ITEM	W x L	CNT	WT
3785A	12 X 12	500	23
3790A	12 X 15	500	28
3793A	13 X 15	500	30
3795A	13 X 18	500	36
3799A	14 X 24	250	26
3674A	16 X 20	250	23
3800A	18 X 20	250	27
3802A	18 X 24	250	33
3683A	20 X 20	250	29
3803A	20 X 24	250	36
3804A	24 X 24	250	44
6 MIL			
3807A	3 X 5	1000	8
3805A	4 X 6	500	9
3815A	6 X 8	500	13
3816A	6 X 9	1000	27
3825A	8 X 10	500	20
3830A	9 X 12	500	26
3835A	10 X 12	500	28
3840A	12 X 12	500	35
3845A	12 X 15	250	21
3850A	13 X 18	250	28
3860A	24 X 24	100	27

BUILD ANY SIZE: Mil: 1.5–6
Width: 1.5"–35" Length: 2"–36"
MORE OPTIONS: Film Color, Printing, Venting, Packaging Details

CONTACT US FOR
MORE INFORMATION

ALTA-PAK MIDWEST
3401 NORTH JACKSON AVE
KANSAS CITY, MO 64117

TO REORDER CALL 816-453-7204

RECLOSABLE BAGS



Comes printed with recycle message

RECLOSABLE BAGS WITH 25% PCR

Our Reclosable Bags with 25% PCR are designed with a portion of Post-Consumer Recycled material, such as bottles from curbside bins, to keep waste out of landfills. A durable zipper closure allows for bag reuse. Due to the nature of PCR, bag clarity is slightly reduced.

TECHNICAL DETAILS

Made from a blend of Low-Density Polyethylene with 25% Post-Consumer Recycled (PCR) material, these feature a side weld construction and hammer sealed zipper closure. Printed with a standard recycle message and packaged in cases.

ITEM	W x L	CNT	WT
2 MIL			
19230	4 X 6	1000	4
19233	6 X 6	1000	6
19235	6 X 9	1000	9
4 MIL			
19237	6 X 9	1000	17
19239	9 X 12	1000	32



RECLOSABLE BAGS WITH HANG HOLES

Our Reclosable Bags with Hang Holes are ideal for display purposes and keep product organized and easy to reach.

TECHNICAL DETAILS

Made from 100% virgin Low-Density Polyethylene that meets FDA/USDA specifications. These feature a 1/4" hang hole and a side weld construction.

Polyethylene with Hang Holes

ITEM	W x L	CNT	WT
2 MIL			
4100A	2 X 3	1000	2
4105A	3 X 4	1000	3
4110A	3 X 5	1000	4
4115A	4 X 4	1000	4
4120A	4 X 6	1000	5
4125A	5 X 8	1000	7
4130A	6 X 9	1000	10
4135A	6 X 10	1000	11
4140A	8 X 10	1000	13
4145A	9 X 12	1000	17
4150A	10 X 12	1000	21
4 MIL			
4200A	3 X 4	1000	5
4205A	3 X 5	1000	6
4210A	4 X 6	1000	9
4215A	5 X 8	1000	14
4220A	6 X 9	1000	19
4225A	8 X 10	1000	27
4230A	9 X 12	1000	35
4235A	10 X 12	500	20
4240A	12 X 15	500	29

BUILD ANY SIZE: Mil: 1.5-6
Width: 2"-35" Length: 3"-36"
MORE OPTIONS: Film Color, Printing, Venting, Packaging Details

Polypropylene with Hang Holes

ITEM	W x L	CNT	WT
2 MIL			
13150	3 X 5	1000	8
13155	4 X 6	1000	13
13190	10 X 12	1000	4

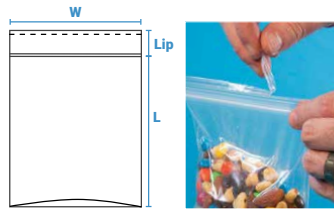

TAMPER-EVIDENT RECLOSABLE BAGS

Our Tamper-Evident Reclosable Bags are designed to ensure that contents are not disturbed prior to use. Product is bottom loaded, then heat sealed, and can later be accessed with a perforated tear strip located above the zipper.

TECHNICAL DETAILS

Made from 100% virgin Low-Density Polyethylene that meets FDA/USDA specifications. All bags feature an open bottom which can be sealed after product loading, a tear perforation above the zipper for easy opening and a side weld construction.

ITEM	W x L	CNT	WT
2 MIL			
3907A	6 X 9	1000	10
3915A	12 X 15	1000	28



RECLOSABLE PART BAGS

Our Reclosable Part Bags are designed for easy inventory organization with separate areas for description and quantity. Large writing area accepts marker or pen.

TECHNICAL DETAILS

Made from 100% virgin Low-Density Polyethylene that meets FDA/USDA specifications. These feature a 1/4" hang hole and a side weld construction.

ITEM	W x L	CNT	WT
4 MIL			
4005	3 X 4	1000	5
4010	4 X 6	1000	9
4015	6 X 8	1000	14
4020	9 X 12	1000	33



RECLOSABLE BAGS WITH WHITE BLOCK

Our Reclosable Bags with White Block are designed for easy labeling with a large writing area that accepts marker or pen.

TECHNICAL DETAILS

Made from 100% virgin Low-Density Polyethylene that meets FDA/USDA specifications. These feature a side weld construction.

ITEM	W x L	CNT	WT
2 MIL			
3935A	2 X 3	1000	2
3940A	3 X 4	1000	3
3945A	3 X 5	1000	4
3948A	4 X 4	1000	4
3950A	4 X 6	1000	5
3960A	5 X 8	1000	8
3962A	6 X 8	1000	9
3970A	6 X 9	1000	10
3972A	8 X 10	1000	14
3975A	9 X 12	1000	18
3976A	10 X 12	1000	20
3977A	10 X 13	1000	21
3979A	12 X 12	1000	24
3980A	12 X 15	1000	28
3982A	13 X 15	1000	31
3983A	13 X 18	1000	38
4 MIL			
3985A	3 X 5	1000	6
3990A	4 X 6	1000	9
3995A	5 X 8	1000	14
3999A	6 X 8	1000	17
4000A	6 X 9	1000	18
4010A	8 X 10	1000	25
4020A	9 X 12	1000	34
4024A	12 X 12	1000	46
4025A	12 X 15	500	28
4030A	13 X 18	500	34

CONTACT US FOR MORE INFORMATION

ALTA-PAK MIDWEST
 3401 NORTH JACKSON AVE
 KANSAS CITY, MO 64117

TO REORDER CALL 816-453-7204

RECLOSABLE BAGS

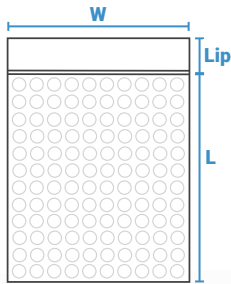

RECLOSABLE BUBBLE BAGS

Our Bubble Reclosable Bags are designed for the transportation and shipment of fragile items through added cushioning and protection.

- ▶ Printed in red "Reusable—Do Not Discard"
- ▶ Protects against impact, moisture, abrasion and dust
- ▶ Meet PPP-B-26, Type I or II, Style 3a

TECHNICAL DETAILS

Made from 100% virgin Low-Density Polyethylene. These feature double walls of 3/16" bubble surrounded by two layers of 3 mil LDPE, a zipper closure, and a side weld construction. Ships as dimensional weight.

ITEM	W x L	CNT	WT
640	4 X 6	50	2
7645	6 X 8	50	3
7650	8 X 10	50	5

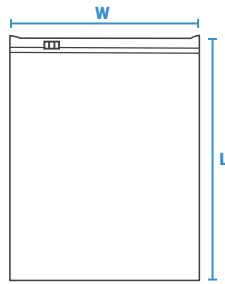

SLIDER TOP BAGS

Our Slider Top Bags allow for a quick, positive closure and are ideal for use with gloves. These can be easily held open for single hand loading and are designed to provide the maximum usable bag width.

TECHNICAL DETAILS

Made from a blend of 100% virgin Low and Linear Low-Density Polyethylene. These feature a side weld construction. All bag openings are approximately 1.75" smaller than bag width to accommodate the slider closure.

ITEM	W x L	CNT	WT
3 MIL			
4064	4 X 6	250	3
4065	6 X 6	250	4
4070	6 X 9	250	5
4067	8 X 7	250	3
4075	8 X 10	250	6
4080	9 X 12	250	6
4073	10 X 7	250	4
4077	10 X 13	250	9
4078	12 X 12	250	10
4085	12 X 15	250	10
4074	12.5 X 9	250	7
4090	13 X 18	250	13
4083	14 X 11	250	9
4087	16 X 12	250	11
4093	16 X 16	250	15
4086	16 X 18	250	16
4079	18 X 20	250	21
4088	18 X 24	250	24
4092	22 X 22	250	27

BUILD ANY SIZE: Mil: 2-4 Width: 4"-24" Length: 4"-24"
MORE OPTIONS: Printing, Venting, Packaging Details

AMBER RECLOSABLE BAGS

Our Amber Reclosable Bags ensure required UV protection during transportation and storage of light sensitive medications.



TECHNICAL DETAILS

Made from a blend of 100% virgin Low and Linear Low-Density Polyethylene with an amber color additive. Meets USP XXII and USP XXIII procedure 66.1 (<10% light transmission from 290nm to 450nm). All bags feature a side weld construction.

ITEM	W x L	CNT	WT
3 MIL			
3867A	3 X 5	1000	5
3870A	4 X 6	1000	7
3873A	6 X 8	1000	13
3875A	8 X 8	1000	17
3880A	9 X 12	1000	27
3883A	12 X 12	1000	35

BUILD ANY SIZE: Mil: 3 Width: 1.5"-30" Length: 2"-36"
MORE OPTIONS: Venting



BIOHAZARD SPECIMEN BAGS

Our Biohazard Specimen Bags are designed for the safe transportation of hazardous chemicals. Outer pouch keeps paperwork separate and dry. Printed with a biohazard symbol and check boxes for processing.

TECHNICAL DETAILS

Made from a blend of 100% virgin Low and Linear Low-Density Polyethylene. These feature a side weld construction.

ITEM	W x L	CNT	WT
2 MIL			
4059	6 X 9	1000	12
4060	8 X 10	1000	18
4061	12 X 15	500	20



CHEMOTHERAPY DRUG TRANSPORT BAGS

Our Chemotherapy Drug Transport Bags are printed with a chemotherapy symbol for easy identification.

TECHNICAL DETAILS

Made from a blend of 100% virgin Low and Linear Low-Density Polyethylene. All bags feature a zipper closure and side weld construction.

ITEM	W x L	CNT	WT
2 MIL			
4056	6 X 9	1000	10
4 MIL			
4057	9 X 12	1000	34
4058	12 X 15	500	27

CONTACT US FOR MORE INFORMATION

ALTA-PAK MIDWEST
 3401 NORTH JACKSON AVE
 KANSAS CITY, MO 64117

TO REORDER CALL 816-453-7204

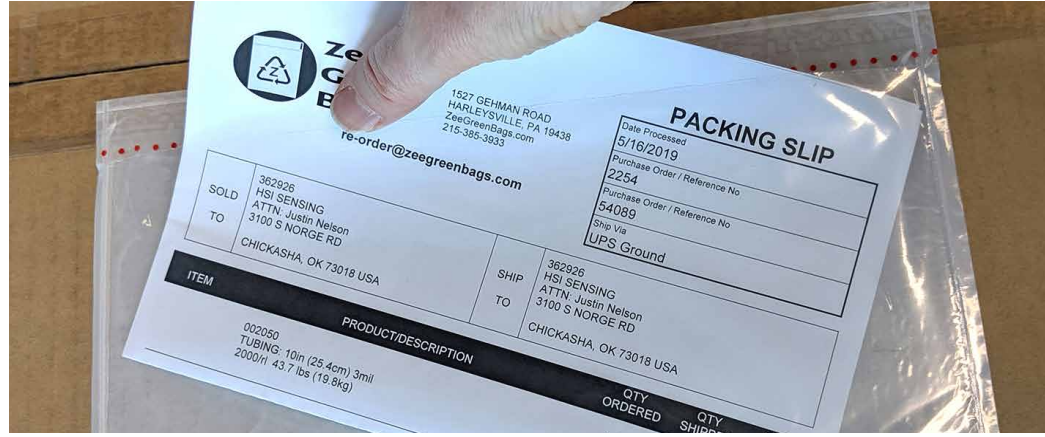
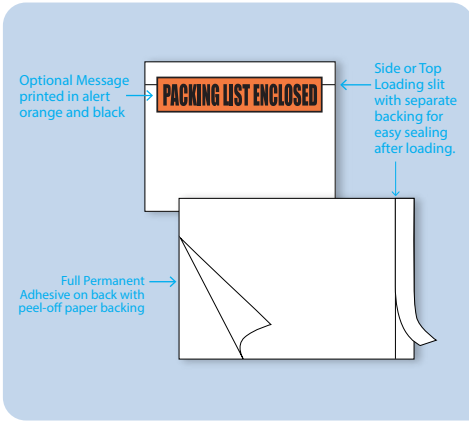

PACKING LIST ENVELOPES

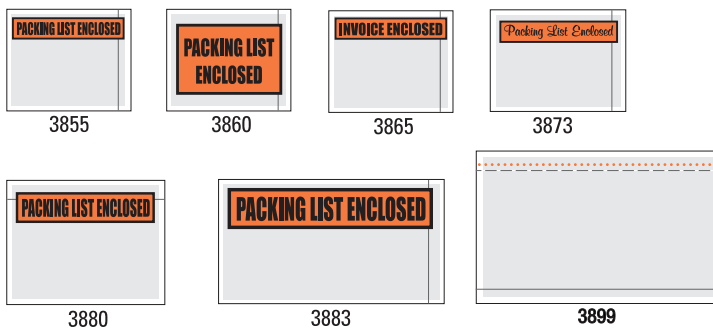

PACKING LIST ENVELOPES – UNPRINTED

ITEM	W x L	CNT	WT
3868	4.5 X 6	1000	8
3875	4.5 X 5.5	1000	7
3893	5.5 X 10	1000	15
3876	6.5 X 10	1000	17
3895	7 X 5.5	1000	11
3897	7 X 10	1000	18
3898	9.5 X 12	500	1
3877	10 X 12	500	16
3899	10.75 X 6.75*	500	10

* Item 3899 is perforated and printed with dots for easy removal of paperwork.

PACKING LIST ENVELOPES – PRINTED

ITEM	W x L	TEXT	CNT	WT
3855	4.5 X 5.5	Packing List Enclosed	1000	7
3860	4.5 X 5.5	Packing List Enclosed	1000	7
3865	4.5 X 5.5	Invoice Enclosed	1000	7
3873	4.5 X 6	Packing List Enclosed	1000	8
3880	7 X 5.5	Packing List Enclosed	1000	11
3883	5.5 X 10	Packing List Enclosed	1000	15

THE BASICS

Our Packing List Envelopes are designed for the secure shipment of documents and provide superior clarity and readability. A pressure sensitive backing sticks to almost any shipping surface and a back loading construction offers tamper-evident protection.

TECHNICAL DETAILS

Made from a blend of 100% virgin Low and Linear Low-Density Polyethylene in 2 mil. These come equipped with self-adhesive backing and are tear resistant to allow for overstuffing. All envelopes are sealed on four sides featuring a slit opening on the self-adhesive side to insert paperwork.

POSTAL-APPROVED LIP & TAPE BAGS

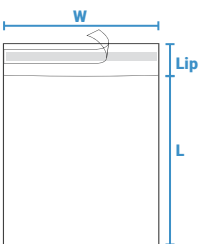

2 MIL 1.5" LIP, PERMANENT SEAL

ITEM	W x L	CNT	WT
13700	6 x 9	1000	9
13650	9 x 12	1000	18
13710	10 x 13	1000	20
13715	12 x 15.5	1000	25

BUILD ANY SIZE: Mil: 1.25–4 Width: 4"–30" Length: 5"–32" Lip: 1.5"–4" MORE OPTIONS: Printing, Venting

THE BASICS

Our Postal-Approved Lip & Tape Bags are ideal for the secure shipment of product and provide enhanced visibility of contents.

TECHNICAL DETAILS

Made from 100% virgin Low-Density Polyethylene with High-Slip and Anti-stat additive. These comply with USPS-T-3204 for automation-rate flat-size mail pieces. All bags feature a 1.5" lip with permanent adhesive and a side weld construction.

CONTACT US FOR MORE INFORMATION

ALTA-PAK MIDWEST
3401 NORTH JACKSON AVE
KANSAS CITY, MO 64117

TO REORDER CALL 816-453-7204



Poly Mailers with 50% Recycled Content have this message printed on them.



Made with 30% post-consumer and 20% post-industrial material

POLY MAILERS

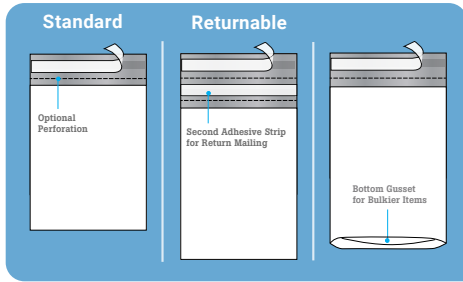

THE BASICS

Our Poly Mailers are designed for the secure shipment of items and are highly popular with online retailers. A tamper-proof and water resistant construction prevents any damage that occur during shipment.

PRODUCT FEATURES

- ▶ A white exterior and silver interior provide complete opacity from prying eyes.
- ▶ Tear-resistant and durable.
- ▶ Tamper-evident, with a permanent self-seal adhesive strip for easy closure.
- ▶ Choice of Standard (non-perforated), Perforated, Returnable, and Expansion (bottom gusseted).
- ▶ Returnable Poly Mailers have a second adhesive strip to allow for easy merchandise returns or a second shipment.
- ▶ Expansion Poly Mailers have a bottom gusset to accommodate bulky items.

TECHNICAL DETAILS

Made from a coextruded blend of Low and Linear Low-Density Polyethylene. All mailers provide featuring a tamper proof permanent adhesive closure and side weld construction.

POLY MAILERS

ITEM	W x L	LIP	CNT	WT
NON-PERFORATED				
5150	6 X 9	1.5"	1000	12
5155	7.5 X 10.5	1.5"	1000	17
5160	9 X 12	1.5"	1000	22
5165	10 X 13	1.5"	1000	26
5170	12 X 15.5	1.5"	500	19
5175	14 X 17	1.5"	500	23
5180	14.5 X 19	1.5"	500	27
5185	19 X 24	2"	200	18
5190	24 X 24	2"	200	22

PERFORATED

5100	6 X 9	1.5"	1000	12
5102	7.5 X 10.5	1.5"	1000	17
5104	9 X 12	1.5"	1000	22
5107	10 X 13	1.5"	1000	26
5110	12 X 15.5	1.5"	500	19
5112	14 X 17	1.5"	500	23
5115	14.5 X 19	1.5"	500	27
5117	19 X 24	2"	200	18
5120	24 X 24	2"	200	22

EXPANSION, NON-PERFORATED

5212	10 X 13 - 2" BG	1.5"	1000	22
5214	11 X 13 - 4" BG	1.5"	500	13
5216	13 X 16 - 4" BG	1.5"	500	19
5218	15 X 20 - 4" BG	1.5"	300	16
5220	20 X 24 - 4" BG	2"	200	17
5222	26 X 28 - 5" BG	2"	100	13

BUILD ANY SIZE:

Mil: 2-5 Width: 4"-36" Length: 4"-36" Lip: 1"-4"

MORE OPTIONS:

Printing, Venting, Packaging Details

RETURNABLE POLY MAILERS

ITEM	W x L	LIP	CNT	WT
5200	12 X 15.5	3"	500	19
5205	14 X 17	3"	500	23
5210	19 X 24	3"	200	17

BUILD ANY SIZE:

Mil: 2.5-4 Width: 4"-36" Length: 4"-36" Lip: 2.5"-4"

MORE OPTIONS:

Printing, Venting, Packaging Details

POLY MAILERS 50% RECYCLED CONTENT

Our Poly Mailers with 50% Recycled Content are designed with a portion of Post-Consumer Recycled (PCR) material, such as bottles from curbside bins, and Post-Industrial Recycled (PIR) material to keep waste out of landfills.

TECHNICAL DETAILS

Made from a coextruded blend of Low-Density Polyethylene with 50% Recycled Content (30% PCR and 20% PIR). These feature a tamper proof permanent adhesive closure and side weld construction.

ITEM	W x L	LIP	CNT	WT
NON-PERFORATED				
19135	10 X 13	1.5"	1000	24
19145	12 X 15.5	1.5"	500	17
19155	14.5 X 19	1.5"	500	25
19165	19 X 24	1.5"	200	17
PERFORATED				
19130	10 X 13	1.5"	1000	24
19140	12 X 15.5	1.5"	500	17
19150	14.5 X 19	1.5"	500	25
19160	19 X 24	1.5"	200	17

MORE OPTIONS:

3 Additional Sizes, Printing

POLY BUBBLE MAILERS



Our Poly Bubble Mailers are shockproof and ideal for shipping smaller fragile or delicate items.

TECHNICAL DETAILS

Made from a coextruded blend of Low-Density Polyethylene lined with 1/8" bubble. A white exterior and silver interior provides complete opacity. All bags feature a 1.5" lip with a permanent adhesive and a side weld construction. Packaged flat in cases. Measured in outside dimensions (O.D.), including the lip.

ITEM	W x L	SIZE	CNT	WT
19170	4 X 8	#000	500	8
19173	5 X 10	#00	250	7
19175	6.5 X 10	#0	250	8
19180	7.25 X 12	#1	100	4
19183	8.5 X 12	#2	100	5
19185	8.5 X 14.5	#3	100	6
19190	9.5 X 14.5	#4	100	6
19193	10.5 X 16	#5	100	8
19195	12.5 X 19	#6	50	6
19197	14.25 X 20	#7	50	7

CONTACT US FOR
MORE INFORMATION

ALTA-PAK MIDWEST
3401 NORTH JACKSON AVE
KANSAS CITY, MO 64117

TO REORDER CALL 816-453-7204

CUSTOM POLY MAILERS

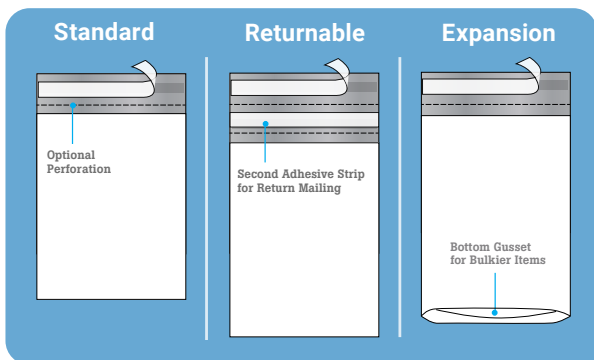

Our Custom Poly Mailers provide a private and secure way to ship items. White on the outside and silver on the inside, these offer complete opacity to keep contents hidden from prying eyes. Choose from a variety of constructions, printed or unprinted:

Perforated or Non-perforated

Select to add a tear strip below the adhesive for easy opening, or choose non-perforated for a tamper-proof construction.

Expandable

These feature a bottom gusset for mailer expansion to accommodate bulkier items.

Returnable

These feature two adhesive strips and two perforations. The top strip folds and seals for initial shipment, and can be opened with the first perforation. The second strip can be folded over and sealed for return shipment.

Printing

Custom design your poly mailer with up to six colors on both sides, spot and process printing. Create a branded image or a full-color, full-bleed mailer.

TECHNICAL DETAILS

Made from a coextruded blend of Low and Linear Low-Density Polyethylene. All mailers feature a tamper proof permanent adhesive closure and side weld construction.



Each construction is available in a range of sizes and gauges. All mailers are water-resistant and feature a tamper-proof permanent adhesive closure and side weld construction. Packaged in cases.

CUSTOM OPTIONS

- ▶ Mil: 2-5 Width: 4"-36" Length: 4"-36" Lip: 1"-4"
- ▶ Returnable Poly Mailers:
Mil: 2.5-4 Width: 4"-36" Length: 4"-36" Lip: 2.5"-4"

CUSTOM OPTIONS WITH 50% RECYCLED CONTENT

Our Poly Mailers with 50% Recycled Content are designed with a portion of Post-Consumer Recycled (PCR) material and Post-Industrial Recycled (PIR) material to keep waste out of landfills.

TECHNICAL DETAILS

Made from a coextruded blend of Low-Density Polyethylene with 50% Recycled Content (30% PCR and 20% PIR). These feature a tamper proof permanent adhesive closure and side weld construction.

CUSTOM OPTIONS

- ▶ Available in 7 sizes, perforated or non-perforated:
7.5" x 10.5"
9" x 12"
10" x 13"
12" x 15.5"
14.5" x 19"
19" x 24"
24" x 24"
- ▶ Custom printing is available up to 3 colors on 2 sides. Note: Full bleed printing is not available.

This message comes positioned on your bag, but can be changed for your own messaging.



Made with 30% post-consumer and 20% post-industrial material

CONTACT US FOR MORE INFORMATION

ALTA-PAK MIDWEST
3401 NORTH JACKSON AVE
KANSAS CITY, MO 64117

TO REORDER CALL 816-453-7204



POLY TUBING

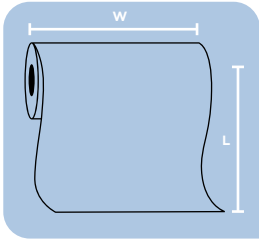

THE BASICS

Our Poly Tubing is suitable for a wide variety of uses and is manufactured to exact specifications to ensure consistent wall thickness and superior clarity. Available in a range of stock sizes or can be customized to your exact specifications.

TECHNICAL DETAILS

Made from a blend of 100% virgin Low and Linear Low-Density Polyethylene that meets FDA/USDA specifications. All tubing is heat sealable and comes on rolls with 3" cores.

1.5 MIL POLY TUBING

ITEM	WIDTH	FT/RL	WT
1800	3"	2000	8
1805	4"	4000	19

2 MIL POLY TUBING

ITEM	WIDTH	FT/RL	WT
1890	1"	1500	2
1900	2"	1500	4
1905	2.5"	1500	6
1910	3"	1500	7
1915*	4"	3000	17
1920*	5"	3000	21
1925*	6"	3000	26
1927*	7"	3000	31
1930*	8"	3000	35
1940*	10"	3000	44
1945*	12"	3000	53
1947*	13"	2700	51
1950*	14"	2700	55
1955*	16"	2700	63
1960*	18"	2400	63
1965*	20"	2100	61
1967*	22"	1800	58
1970*	24"	1800	64
1972*	26"	1650	63
1975*	28"	1650	68
1977*	30"	1500	66
1980*	32"	1500	71
1985*	36"	1350	72
1990*	40"	1200	71
1995*	48"	900	65

3 MIL POLY TUBING

ITEM	WIDTH	FT/RL	WT
2000	1"	1000	3
2005	1.5"	1000	5
2010	2"	1000	6
2020	3"	1000	8
2025*	4"	2000	18
2030*	5"	2000	22
2035*	6"	2000	27
2040*	8"	2000	35
2045*	9"	2000	40

3 MIL POLY TUBING

ITEM	WIDTH	FT/RL	WT
2050*	10"	2000	44
2055*	12"	2000	52
2060*	14"	1800	55
2065*	16"	1800	62
2070*	18"	1600	62
2075*	20"	1400	61
2080*	24"	1200	64
2085*	28"	1100	67
2087*	30"	1000	66
2090*	32"	1000	70
2092*	36"	900	71
2093*	40"	800	71
2094*	48"	600	65

4 MIL POLY TUBING

ITEM	WIDTH	FT/RL	WT
2095	1"	750	4
3005	2"	750	6
3010	2.5"	750	7
3015	3"	750	8
3020*	4"	1500	18
3025*	5"	1500	23
3030*	6"	1500	27
3032*	7"	1500	31
3035*	8"	1500	35
3040*	9"	1500	40
3045*	10"	1500	44
3050*	12"	1500	53
3055*	14"	1350	55
3060*	16"	1350	63
3065*	18"	1200	63
3070*	20"	1050	61
3072*	22"	900	58
3075*	24"	900	64
3077*	26"	825	63
3082*	30"	750	66
3090*	36"	675	72
3095*	40"	600	71
3100*	48"	450	65
3108*	60"	350	67



ENGINEERED AND MANUFACTURED
IN THE U.S.A.

CONTACT US FOR
MORE INFORMATION

ALTA-PAK MIDWEST
3401 NORTH JACKSON AVE
KANSAS CITY, MO 64117

TO REORDER CALL 816-453-7204

POLY TUBING (CONT.)



6 MIL POLY TUBING

ITEM	WIDTH	FT/RL	WT
2105	3"	500	8
2106*	4"	1000	19
2107*	5"	1000	24
2108*	6"	1000	28
2109*	7"	1000	33
2110*	8"	1000	37
2111*	9"	1000	42
2112*	10"	1000	46
2114*	12"	1000	55
2115*	13"	900	54
2116*	14"	900	58
2118*	16"	900	66
2119*	18"	800	66
2120*	20"	700	64
2122*	22"	600	61
2124*	24"	600	67
2128*	28"	550	71
2130*	30"	500	69
2132*	32"	500	74
2135*	36"	450	75
2140*	40"	400	75
2145*	48"	300	68

BUILD ANY SIZE: **Mil: 0.75-8 Width: 1"-98"**
 MORE OPTIONS: **Materials, Film Color, Printing, Venting, Packaging Details**

CLEAN ROOM CLASS 100 TUBING

Our Clean Room Tubing is manufactured in an environment that is free from contaminants. These meet the performance parameters as outlined in ISO 14644-1 for an ISO Class 5 clean room at 0.5 microns. Available in a variety of sizes and gauges.

TECHNICAL DETAILS

Made from 100% virgin Low-Density Polyethylene. All Tubing is heat sealable and feature a tubular. Available on rolls with 3" cores, sub packed or in double poly-lined cases.

Pink Anti-Static Tubing

ITEM	WIDTH	FT/RL	WT
4 MIL - 3" CORE			
12515*	10"	750	26
12520*	12"	750	30
12545*	24"	750	60
12550*	32"	500	55

BUILD ANY SIZE:
Mil: 0.75-8 Width: 4"-98"
 MORE OPTIONS:
Printing, Venting, Packaging Details

Black Conductive Tubing

ITEM	WIDTH	FT/RL	WT
4 MIL			
5706	4"	750	14
5708	6"	750	21
5709	8"	750	28
5710	10"	750	35
5711	12"	750	40
5712	14"	750	47

BUILD ANY SIZE: **Mil: 2-10 Width: 2"-60"**
 MORE OPTIONS: **Packaging Details**



POLY SLEEVES

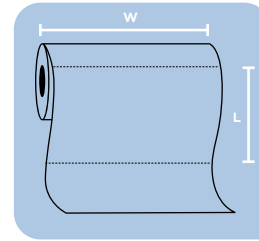

THE BASICS

Our Poly Sleeves can be perforated on rolls or packaged in cases for easy product loading. Suitable for a variety of applications.

TECHNICAL DETAILS

Made from a blend of 100% virgin Low and Linear Low-Density Polyethylene that meets FDA/USDA specifications. All sleeves are heat sealable and are available in Layflat or Gusseted constructions.

LAYFLAT SLEEVES: **Mil: 0.75-8 Width: 4"-98" Length: 4"-288"**
 GUSSETED SLEEVES: **Mil: 0.75-6 Width: 4"-96" Depth: 3"-72" Length: 8"-288"**
 MORE OPTIONS: **Materials, Film Color, Printing, Venting, Packaging Details**

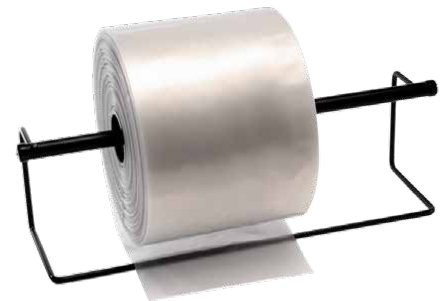

ROLL DISPENSERS

Made of steel, these can accommodate a roll of up to 13.5" in diameter.

ITEM	SIZE	CNT	WT
4830	12"	1	2
4832	24"	1	3

CONTACT US FOR MORE INFORMATION

ALTA-PAK MIDWEST
 3401 NORTH JACKSON AVE
 KANSAS CITY, MO 64117

TO REORDER CALL 816-453-7204



CONSTRUCTION FILM

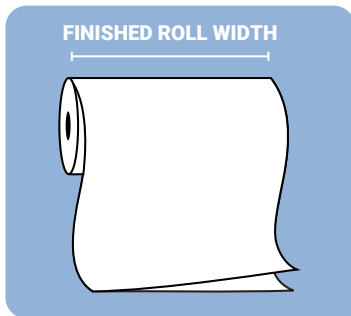

THE BASICS

Our Construction Film provides protection from weather, dust, debris, and prying eyes. Ideal as a vapor barrier or drop cloth.

TECHNICAL DETAILS

Made from a blend of Low and Linear Low-Density Polyethylene. These feature a slit gusset or center fold construction and are available on coreless rolls or rolls with 1.5" or 3" cores.



WHAT IS "NATURAL" COLOR?

G30 film is a transparent white. While it looks white compared to standard clear, it still exhibits good contact clarity. The top film in the photo is G30 transparent white film.

CLEAR FILM

ITEM	W x L	CORE	WT
2 MIL			
4380*	50" X 200'	3"	9
4385*	100" X 200'	3"	17
4390*	12' X 200'	3"	24
3 MIL			
4397	10' X 100'	1.5"	14
4404	20' X 100'	1.5"	29
4395*	16' X 200'	3"	31
4 MIL			
4405*	3' X 100'	3"	7
4410	4' X 100'	-	9
4415	6' X 100'	1.5"	12
4420	8' X 100'	1.5"	16
4425	10' X 100'	1.5"	20
4430	12' X 100'	1.5"	24
4440	16' X 100'	1.5"	32
4445	20' X 100'	1.5"	39
6 MIL			
4450*	3' X 100'	3"	9
4452*	4' X 100'	3"	13
4455	6' X 100'	1.5"	19
4460	8' X 100'	1.5"	25
4465	10' X 100'	1.5"	30
4485	20' X 100'	1.5"	57

BLACK FILM

ITEM	W x L	CORE	WT
4 MIL			
11005	4' X 100'	-	9
11010	6' X 100'	1.5"	13
11020	10' X 100'	1.5"	21
6 MIL			
11055	10' X 100'	1.5"	30
11070	20' X 100'	1.5"	58

CONSTRUCTION FILM WITH G30 - NATURAL

Includes a G30 additive engineered for greater impact and tear strength.

G30 - NATURAL

ITEM	W x L	CORE	WT
2 MIL			
4380G*	50" X 200'	3"	10
4385G*	100" X 200'	3"	18
4390G*	12' X 200'	3"	25
4395G*	16' X 200'	3"	32
4 MIL			
4405G*	3' X 100'	3"	7
4410G*	4' X 100'	3"	9
4415G*	6' X 100'	3"	13
4420G*	8' X 100'	3"	17
4425G*	10' X 100'	3"	21
4430G*	12' X 100'	3"	25
4440G*	16' X 100'	3"	32
4445G*	20' X 100'	3"	40
6 MIL			
4452G*	4' X 100'	3"	14
4460G*	8' X 100'	3"	25
4465G*	10' X 100'	3"	32
4480G*	16' X 100'	3"	50
4485G*	20' X 100'	3"	56

***smart tech bags®**

ENGINEERED AND MANUFACTURED
IN THE U.S.A.

CONTACT US FOR
MORE INFORMATION

ALTA-PAK MIDWEST
3401 NORTH JACKSON AVE
KANSAS CITY, MO 64117

TO REORDER CALL 816-453-7204

SHEETING

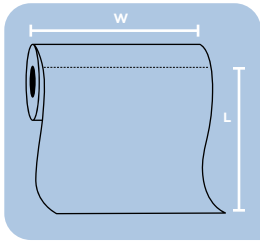

PALLET TOP SHEETING

Our Pallet Top Sheeting keeps pallet tops clean and dry during shipment and storage. Simply cover the pallet then strap or stretch wrap as needed.

TECHNICAL DETAILS

Made from a blend of 100% virgin Low and Linear Low-Density Polyethylene. All sheets are center folded and come perforated on rolls with 3" cores.

ITEM	W x L	MIL	CNT	WT
CLEAR FILM				
5982*	60 X 60	1	400	48
5984*	60 X 60	1.25	250	38
5955*	60 X 60	1.5	250	42
4973*	60 X 60	2	175	40
5986*	72 X 72	1	300	52
5975*	72 X 72	1.5	200	49
5977*	72 X 72	2	150	49
WHITE FILM				
4972*	60 X 60	2	175	40

BUILD ANY SIZE: **Mil: 1-8 Width: 4"-98" Length: 4"-1200"**
 MORE OPTIONS: **Materials, Film Color, Printing, Venting, Packaging Details**

INDIVIDUALLY CUT SHEETS*

Our Individually Cut Sheets serve as a barrier from dust, dirt, and other damaging debris. Available to custom order to your specifications.

TECHNICAL DETAILS

Made from a blend of 100% virgin Low and Linear Low-Density Polyethylene. All sheets are available packaged in cases.

BUILD ANY SIZE: **Mil: 1-8 Width: 4"-98" Length: 6"-60"**
 MORE OPTIONS: **Materials, Film Color, Venting, Packaging Details**

SHEETS ON ROLLS

Our Sheets on Rolls serve as ideal drop cloths, dust covers, or interleaving to guard against moisture and debris.

TECHNICAL DETAILS

Made from a blend of 100% virgin Low and Linear Low-Density Polyethylene. All sheets are center folded and come perforated on rolls with 3" cores.

1.5 MIL SHEETING

ITEM	W X L	CNT	WT
5900*	24 X 24	1000	27
5905*	30 X 30	900	37
5910*	36 X 36	800	47
5915*	36 X 48	600	47
5930*	48 X 48	600	64
5935*	48 X 60	450	59
5940*	48 X 72	400	64
5945*	54 X 54	250	34
5950*	54 X 60	250	38
5955*	60 X 60	250	42
5960*	60 X 72	225	45
5975*	72 X 72	200	49
5980*	72 X 96	150	49
6005*	108 X 108	100	55

BUILD ANY SIZE:
Mil: 1-8 Width: 4"-98" Length: 4"-1200"
 MORE OPTIONS: **Materials, Film Color, Printing, Venting, Packaging Details**



ENGINEERED AND MANUFACTURED
 IN THE U.S.A.



MACHINE GRADE TOP SHEETING

Our Machine Grade Top Sheeting provides coverage for the top of a pallet during the stretch wrapping process and provides protection from moisture and damaging debris.

TECHNICAL DETAILS

Made from 100% virgin Low and Linear Low-Density Polyethylene with an anti-stat additive to allow for unimpeded application. Available single wound on 3" cores.

2 MIL MACHINE GRADE SHEETING

ITEM	WIDTH	RL/DIA	FT/RL	WT
13960	60"	10"	2600	114
13970	72"	9"	2000	106

* Note: This product has a 3-roll minimum order.

BUILD ANY SIZE: **Mil: 1-8 Width: 56"-76"**
 MORE OPTIONS: **Film Colors Clear, Black or White**

CONTINUOUS SHEETING*

Our Continuous Sheeting is suitable for a wide range of applications and serves as a barrier from moisture, dust, and other damaging debris. Available to custom order to your specifications.

TECHNICAL DETAILS

Made from a blend of 100% virgin Low and Linear Low-Density Polyethylene. Available as single wound, center folded or gusseted and wound on rolls with 3" cores.

BUILD ANY SIZE:
 Single Wound: **Mil: 2-8 Width: 24"-98"**
 Center Fold: **Mil: 1-8 Width: 4"-98"**
 Gusseted: **Mil: 1-6 Width: 4"-96" Depth: 3"-72"**
 MORE OPTIONS: **Materials, Film Color, Venting, Packaging Details**

CONTACT US FOR
 MORE INFORMATION

ALTA-PAK MIDWEST
 3401 NORTH JACKSON AVE
 KANSAS CITY, MO 64117

TO REORDER CALL 816-453-7204



BIN & GAYLORD LINERS/PALLET COVERS

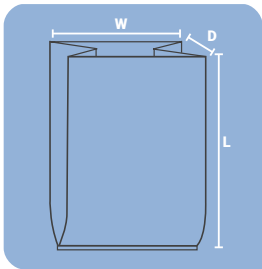

THE BASICS

Our Bin & Gaylord Liners/ Pallet Covers act as a barrier or liner from dirt, debris, inclement weather and other damaging factors. They may also be utilized to keep contents secure.

- ▶ Great for bin and gaylord lining
- ▶ Keeps dirt, dust and moisture off equipment
- ▶ Perforated on rolls for fast and easy dispensing.

TECHNICAL DETAILS

Made from a blend of 100% virgin Low and Linear Low-Density Polyethylene. All sheets are center folded and come perforated on rolls with 3" cores.

***smart tech bags®**

ENGINEERED AND MANUFACTURED IN THE U.S.A.

LINERS/COVERS

ITEM	W x D x L	CNT	WT
1 MIL			
1400R*	48 X 42 X 48	150	43
1.25 MIL			
9975*	54 X 44 X 96	100	78
1.5 MIL			
10000*	32 X 28 X 48	200	53
10010*	32 X 28 X 72	135	54
10045*	36 X 28 X 60	160	57
10095*	36 X 36 X 60	130	53
10110*	42 X 32 X 54	140	53
10115*	42 X 32 X 60	130	54
10160*	44 X 36 X 80	100	60
10170*	44 X 36 X 96	80	58
10195*	46 X 44 X 80	70	48
10180*	48 X 36 X 72	110	63
10210*	48 X 46 X 72	75	48
10215*	48 X 46 X 96	60	51
10240*	51 X 49 X 73	75	52
10242*	51 X 49 X 85	60	49
10245*	51 X 49 X 97	50	47
10250*	52 X 48 X 96	60	55
10255*	52 X 48 X 108	50	51
10225*	53 X 42 X 78	65	46
10230*	54 X 44 X 72	75	51
10235*	54 X 44 X 96	60	54
10265*	58 X 46 X 96	60	57
10270*	58 X 46 X 108	50	54
2 MIL			
10300*	32 X 28 X 48	160	57
10305*	32 X 28 X 60	130	58
10310*	32 X 28 X 72	110	59
10315*	32 X 28 X 84	90	56
10320*	32 X 28 X 96	80	57
10345*	36 X 28 X 60	130	62
10370*	36 X 32 X 48	160	65
10375*	36 X 32 X 60	130	66
10390*	36 X 36 X 48	125	54
10400*	36 X 36 X 72	80	52
10410*	42 X 32 X 54	110	55
10415*	42 X 32 X 60	100	56

LINERS/COVERS

ITEM	W x D x L	CNT	WT
10420*	42 X 32 X 72	80	54
10425*	42 X 32 X 84	70	55
10460*	44 X 36 X 80	75	61
10465*	44 X 36 X 88	70	62
10470*	44 X 36 X 96	60	58
10475*	44 X 36 X 108	55	60
10495*	46 X 44 X 80	55	51
10500*	46 X 44 X 100	45	52
10435*	48 X 30 X 60	100	59
10440*	48 X 30 X 72	80	57
10480*	48 X 36 X 72	80	61
10485*	48 X 36 X 96	60	61
10490*	48 X 42 X 48	100	57
10510*	48 X 46 X 72	60	52
10515*	48 X 46 X 96	45	52
10520*	48 X 46 X 126	35	53
10522*	51 X 49 X 73	55	51
10523*	51 X 49 X 85	50	54
10524*	51 X 49 X 97	40	50
10550*	52 X 48 X 96	45	55
10555*	52 X 48 X 108	40	55
10525*	53 X 42 X 78	55	52
10530*	54 X 44 X 72	60	54
10535*	54 X 44 X 96	45	54
10545*	54 X 44 X 132	30	50
10565*	58 X 46 X 96	45	58
10575*	58 X 46 X 125	35	58
10580*	68 X 65 X 82	50	70
3 MIL			
1800R*	48 X 46 X 72	45	57
1815R*	51 X 49 X 85	35	56
1817R*	51 X 49 X 97	30	52
1825R*	54 X 44 X 72	40	54
1820R*	54 X 44 X 96	30	54
4 MIL			
10600*	32 X 28 X 48	80	57
10605*	32 X 28 X 60	65	58
10610*	32 X 28 X 72	55	59
10615*	32 X 28 X 84	45	56
10620*	32 X 28 X 96	40	57

LINERS/COVERS

ITEM	W x D x L	CNT	WT
10645*	36 X 28 X 60	65	62
10655*	36 X 28 X 96	40	61
10670*	36 X 32 X 48	80	65
10675*	36 X 32 X 60	65	66
10690*	36 X 36 X 48	60	52
10695*	36 X 36 X 60	50	54
10700*	36 X 36 X 72	40	52
10705*	36 X 36 X 108	25	49
10630*	40 X 22 X 72	55	62
10710*	42 X 32 X 54	55	55
10715*	42 X 32 X 60	50	56
10720*	42 X 32 X 72	40	54
10725*	42 X 32 X 84	35	55
10790*	44 X 36 X 80	35	57
10760*	44 X 36 X 88	35	62
10770*	44 X 36 X 108	25	55
10772*	44 X 44 X 70	25	40
10795*	46 X 44 X 80	35	63
10800*	46 X 44 X 100	30	68
10735*	48 X 30 X 60	50	59
10775*	48 X 36 X 72	40	61
10810*	48 X 46 X 72	35	60
10815*	48 X 46 X 96	25	57
10817*	50 X 44 X 57	25	36
10819*	50 X 48 X 84	25	53
10818*	51 X 49 X 73	30	56
10820*	51 X 49 X 85	25	54
10821*	51 X 49 X 97	20	50
10822*	52 X 43 X 70	25	43
10850*	52 X 48 X 96	25	61
10860*	52 X 48 X 120	20	61
10825*	53 X 42 X 78	35	66
10830*	54 X 44 X 72	30	54
10835*	54 X 44 X 96	25	60
10840*	54 X 44 X 120	20	60
10845*	54 X 44 X 132	20	65
10865*	58 X 46 X 96	25	64
10875*	58 X 46 X 125	20	66
10878*	68 X 65 X 82	25	70

CONTACT US FOR MORE INFORMATION

ALTA-PAK MIDWEST
3401 NORTH JACKSON AVE
KANSAS CITY, MO 64117

TO REORDER CALL 816-453-7204

BIN & GAYLORD LINERS/PALLET COVERS



PALLET COVERS – UVI/UVA

Our Pallet Covers with UVA/UVI provide protection from the sun's harmful UV rays and other damaging elements, such as dust, dirt, and additional weathering. These are an excellent choice for product in outdoor storage.

TECHNICAL DETAILS

Made from a blend of 100% virgin Low and Linear Low-Density Polyethylene with 1.5% UVI/UVA. These are heat sealable and feature a bottom seal construction. Packaged on rolls with 3" cores.

BLACK UVI/UVA COVERS

ITEM	W X D X L	CNT	WT
2 MIL			
10880*	50 X 42 X 69	65	53
10890*	51 X 49 X 73	55	51
10892*	51 X 49 X 85	50	54
10894*	51 X 49 X 97	45	56
3 MIL			
10910*	51 X 49 X 73	40	55
10912*	51 X 49 X 85	35	56
10914*	51 X 49 X 97	30	55

BUILD ANY SIZE: Mil: 1.5–6
Width: 32"–133" Length: 48"–132"
MORE OPTIONS: Printing, Venting, Packaging Details

SHRINK BAGS & FILM

SHRINK BAGS ON ROLLS

Our Shrink Bags are designed to protect pallets and secure loads during transportation. Once the bag is placed over the product, heat is then applied to the film. This results in a glove like cover that prevents the contents from shifting or moving out of place.

Shrink Bags are often used in place of stretch film, here's why:

- ▶ They provide stronger containment for pallets and loads that are heavier, irregularly shaped or will be in outside storage.
- ▶ They serve as a quicker alternative in the palletization process, as they are entirely in one piece.

Shrink Bags may be used to cover pallets containing the following products:

- ▶ Corrugated gaylords
- ▶ Furniture
- ▶ Bricks and blocks
- ▶ Bags of aggregate
- ▶ Sand
- ▶ Other irregularly shaped objects

TECHNICAL DETAILS

Made from a blend of Low-Density Polyethylene with a High Slip additive. These can be shrunk using a heat gun or integral heat tunnel and provide a secure glove-like cover after heat is applied. All bags are available on rolls with 3" cores and open from the side.



4 MIL PALLET-SIZE SHRINK BAGS

ITEM	W X D X L	CNT	WT
13500	44 X 44 X 70	25	40
13510	48 X 46 X 72	25	43
13520	50 X 44 X 57	25	34
13530	50 X 48 X 84	25	52
13540	52 X 43 X 70	25	42

BUILD ANY SIZE: Mil: 1–8.5*
Width+Depth: 24"–125" Length: 24"–300"
MORE OPTIONS: Materials, Film Color, Venting, Packaging Details

* Maximum Mil for Gusseted is 7.5 Mil.



SHRINK BUNDLING FILM

Our Shrink Bundling Film is designed for use on automated packaging equipment with integral heat tunnels for a "bullseye" closure. This film ensures that heavier product is securely packaged and will not fall out of place.

TECHNICAL DETAILS

Made from a three-layer blend of Polyethylene and is engineered to provide superior clarity, tensile strength and puncture resistance. All film demonstrates a consistent shrink performance of 60–80% (MD) and 0–20% (TD). Packaged on rolls with 3" cores.

2 MIL

ITEM	WIDTH	FT/RL	WT
13550	16"	4200	54
13552	18"	4200	61
13554	20"	4200	67
13556	22"	4200	74
13558	24"	4200	80

CONTACT US FOR
MORE INFORMATION

ALTA-PAK MIDWEST
3401 NORTH JACKSON AVE
KANSAS CITY, MO 64117

TO REORDER CALL 816-453-7204

STRETCH FILM



STRETCH FILM BY BERRY

Berry Global is an industry pioneer for oriented, high-strength films. Their commitment to innovation has kept Berry a leader in stretch film technology for over 40 years, with next-generation solutions helping customers do more with less. Choose Berry Hand Stretch Film for an ergonomically superior design, or upgrade to Berry Machine Stretch Film for those higher volume loads that require precise speed and consistency.



MACHINE STRETCH FILM BY BERRY*

Made from a blend of Linear Low-Density Polyethylene. Available in the most popular sizes of blown or cast film in gauges from 51 to 115 gauge, with varying cling types (100 gauge = 1 mil). All film is provided on rolls with 3" cores and is available bulk packed on a pallet. Sold by the pallet.

ADVANTAGE™ MACHINE FILM

Versatile, cast machine film with one-sided cling, works well for most applications, provides outstanding performance consistency and containment.

ITEM	WIDTH	GAUGE	FT/RL	RL/PALLET	WT/PALLET
14123	20"	55	8000	40	1408
14125	20"	60	7500	40	1440
14127	20"	65	6500	40	1352
14128	20"	70	6000	40	1344
14129	20"	80	5500	40	1408
14130	20"	90	5000	40	1440
14132	20"	105	4250	40	1428
14134	20"	115	3500	40	1288
14135	30"	80	5500	20	1056

MAXPLUS2™ MACHINE FILM

Excellent loading force, cast machine film with differential cling, high clarity film with superior puncture and tear resistance.

ITEM	WIDTH	GAUGE	FT/RL	RL/PALLET	WT/PALLET
14141	20"	80	6000	40	1536
14143	30"	115	4000	20	1104

PERFORMANCE PLUS® MACHINE FILM

Functional, multi-use, blown machine film with two-sided cling. Performs well in dusty, dirty and cold environments.

ITEM	WIDTH	GAUGE	FT/RL	RL/PALLET	WT/PALLET
14145	20"	80	6000	40	1536

T-FILM™ MACHINE FILM

Adaptable, cast machine film with differential cling, high containment at low pre-stretch levels.

ITEM	WIDTH	GAUGE	FT/RL	RL/PALLET	WT/PALLET
14155	20"	80	5000	40	1280

ALPHAONE™ MACHINE FILM

Multipurpose, cast machine film with two-sided cling, provides outstanding pallet integrity, great for turn table and other low-speed equipment.

ITEM	WIDTH	GAUGE	FT/RL	RL/PALLET	WT/PALLET
14165	20"	80	5000	40	1280
14167	20"	90	5000	40	1440

REVOLUTIONQ™ MACHINE FILM

Exceptional film memory, cast machine film with one-sided cling and outside slip. Ideal abrasion reduction properties, designed to release quietly and easily from the roll.

ITEM	WIDTH	GAUGE	FT/RL	RL/PALLET	WT/PALLET
14187	20"	51	9000	40	1469
14190	20"	57	7500	40	1368
14193	20"	63	7250	40	1462
14198	30"	51	9000	20	1102
14199	30"	71	6000	20	1022

CONTACT US FOR
MORE INFORMATION

ALTA-PAK MIDWEST
3401 NORTH JACKSON AVE
KANSAS CITY, MO 64117

TO REORDER CALL 816-453-7204

STRETCH FILM



HAND STRETCH FILM BY BERRY

Made from a blend of Linear Low-Density Polyethylene. Available in the most popular sizes of blown, cast, pre-stretched and narrow width banding film in gauges from 29 to 118 gauge, with varying cling types (100 gauge = 1 mil). All film is available in either a white or kraft box, with Hand Stretch packaged 4 rolls per case. Sold in pallet or case quantities.

Hand Stretch Film pricing is market sensitive. Contact your Rep to get current pricing.



Cost-effective, multipurpose conventional cast hand film with two-sided cling.

FILM BY CASE

ITEM	WIDTH	GAUGE	FT/RL	RL/CS	WT/CS
14002	16"	65	1500	4	27
14035	18"	65	1500	4	30
14045	18"	80	1500	4	37

FILM BY PALLET*

ITEM	WIDTH	GAUGE	FT/RL	RL/PALLET	WT/PALLET
17145	16"	65	1500	192	1198
17147	18"	65	1500	192	1348
17150	18"	80	1500	192	1659



High stretch, clear, blown hand film with two-sided cling, wraps corners well, quick wrap and fast wipe down film.

FILM BY CASE

ITEM	WIDTH	GAUGE	FT/RL	RL/CS	WT/CS
14016	18"	70	1500	4	32
14020	18"	79	1500	4	36

FILM BY PALLET*

ITEM	WIDTH	GAUGE	FT/RL	RL/PALLET	WT/PALLET
17135	18"	79	1500	192	1638
17140	18"	118	1000	192	1632



Stiff, clear, cast hand film with differential cling provides high load containment for most applications. Easy and quiet unwind from the roll.

FILM BY CASE

ITEM	WIDTH	GAUGE	FT/RL	RL/CS	WT/CS
14003	16"	47	1476	4	20
14004	18"	47	1476	4	22

FILM BY PALLET*

ITEM	WIDTH	GAUGE	FT/RL	RL/PALLET	WT/PALLET
17125	16"	47	1476	192	852
17130	18"	47	1476	192	958



PRE-STRETCHED HAND FILM BY BERRY



Light-weight, blown pre-stretch hand film with differential cling. Provides excellent puncture and tear resistance.

FILM BY CASE

ITEM	WIDTH	GAUGE	FT/RL	RL/CS	WT/CS
14070	15"	33	1450	4	13
14072	17.7"	29	1450	4	13
14074	17.7"	38	1450	4	17
14076	17.7"	33	1450	4	15

FILM BY PALLET*

ITEM	WIDTH	GAUGE	FT/RL	RL/PALLET	WT/PALLET
17170*	15"	29	1450	144	396

* Item 17170 has a 5 pallet minimum



NARROW WIDTH BANDING FILM

ITEM	WIDTH	GAUGE	FT/RL	RL/CS	WT/CS
WITH PLASTIC DISPENSER, 1/CS					
14110	3"	80	1000	18	17
14115	5"	80	1000	12	24
WITH EXTENDED CORE					
14120	5"	80	1000	15	24

CONTACT US FOR MORE INFORMATION

ALTA-PAK MIDWEST
3401 NORTH JACKSON AVE
KANSAS CITY, MO 64117

TO REORDER CALL 816-453-7204



HIGH-DENSITY (HD) LINERS



THE BASICS

Our High-Density Can Liners are ideal for heavy, wet, or non-sharp waste. HDPE offers superior moisture and vapor resistance, which allows it to contain odors better than LDPE. It can also be extruded at thinner gauges.

PRODUCT FEATURES

- ▶ Made with 100% prime HDPE
- ▶ 100% Recyclable
- ▶ Star-sealed
- ▶ Packaged in convenient dispenser boxes

TECHNICAL DETAILS

Made from 100% virgin High-Density Polyethylene. All liners come flat packed in cases or wound on coreless rolls and feature a star seal bottom construction.

HD CORELESS ROLLS

LINERS						
ITEM	W x L	MIC	COLOR	BAGS/RL	CNT	WT
7 - 10 GALLON						
5841	24 X 24	6	NAT	50/20	1000	10
12 - 16 GALLON						
5843	24 x 33	8	NAT	50/20	1000	18
20 - 30 GALLON						
5845	30 X 37	10	NAT	25/20	500	15
31 - 33 GALLON						
5849	33 X 40	11	NAT	25/20	500	20
5850	33 X 40	16	NAT	25/10	250	15
40 - 45 GALLON						
5851	40 X 48	16	NAT	25/10	250	21
5853	40 X 48	16	BLK	25/10	250	21
56 GALLON GLUTTON						
5857	43 X 48	16	NAT	25/8	200	18
5860	43 X 48	22	BLK	25/6	150	19
55 - 60 GALLON						
5859	38 X 60	16	NAT	25/8	200	20
5862	38 X 60	22	BLK	25/6	150	21

HD FLAT PACKED

LINERS						
ITEM	W x L	MIC	COLOR	CNT	WT	
12-16 GALLON						
5805	24 X 33	8	NAT	1000	18	
20-30 GALLON						
5810	30 X 37	10	NAT	500	15	
5815	30 X 37	13	NAT	500	20	
31-33 GALLON						
5820	33 X 40	13	NAT	500	24	
5822	33 X 40	16	NAT	250	15	
40-45 GALLON						
5825	40 X 48	14	NAT	250	19	
5830	40 X 48	16	NAT	250	21	
56 GALLON - GLUTTON						
5832	43 X 48	16	NAT	200	18	
55-60 GALLON						
5837	38 X 60	17	NAT	200	21	
5838	38 X 60	22	BLK	150	21	

BUILD ANY SIZE:
Microns: 6-24 Width: 19"-54"
Length: 19"-80"
 MORE OPTIONS:
Film Color, Packaging Details

CONTACT US FOR
 MORE INFORMATION

ALTA-PAK MIDWEST
 3401 NORTH JACKSON AVE
 KANSAS CITY, MO 64117

TO REORDER CALL 816-453-7204

LINEAR LOW-DENSITY LINERS

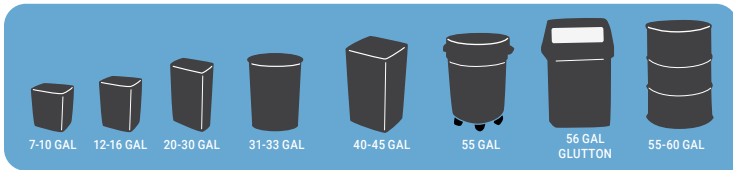

THE BASICS

Our LLD Liners are designed for puncture resistance and flexibility. These can be used to dispose of lawn debris, broken glass, rough food waster and general office refuse.

PRODUCT FEATURES

- ▶ 0.4–2 mil polyethylene
- ▶ Black and clear bags available in each size
- ▶ Custom sizes available up to 70" wide, in gauges of 0.75–8.0 mil

TECHNICAL DETAILS

Made from 100% virgin Linear Low-Density Polyethylene. All liners come on coreless rolls packaged in convenient dispenser boxes and feature a star-seal construction.

LINERS

ITEM	W x L	MIL	COLOR	BAGS/RL	CNT	WT
7 - 10 GALLON						
19000	24 X 23	0.4	CLR	50/20	1000	16
19005	24 X 23	0.7	CLR	50/10	500	14
12 - 16 GALLON						
19010	24 X 32	0.45	CLR	50/10	500	12
19015	24 X 32	0.45	BLK	50/10	500	12
19020	24 X 32	0.7	CLR	50/10	500	19
20 - 30 GALLON						
19025	30 X 36	0.5	CLR	25/10	250	10
19030	30 X 36	0.7	CLR	25/10	250	14
19035	30 X 36	0.9	CLR	25/10	250	17
31 - 33 GALLON						
19040	33 X 39	0.5	CLR	25/10	250	12
19045	33 X 39	1.2	CLR	25/6	150	17
40 - 45 GALLON						
19050	40 X 46	0.7	CLR	25/10	250	23
19055	40 X 46	0.7	BLK	25/10	250	23
19060	40 X 46	0.9	CLR	20/5	100	12
19065	40 X 46	1.2	CLR	20/5	100	16
19070	40 X 46	1.2	BLK	20/5	100	16
55 GALLON						
19075	36 X 58	0.65	CLR	25/8	200	19
19080	36 X 58	0.9	CLR	20/5	100	13
19085	36 X 58	0.9	BLK	20/5	100	13
56 GALLON GLUTTON						
19090	42.5 X 47	0.9	CLR	20/5	100	13
19095	42.5 X 47	0.9	BLK	20/5	100	13
60 GALLON						
19100	38 X 58	0.9	CLR	20/5	100	14
19105	38 X 58	0.9	BLK	20/5	100	14
19110	38 X 58	1.5	BLK	10/10	100	23
19115	38 X 58	1.5	CLR	10/10	100	23

HEAVY DUTY TRASH LINERS AND COMPACTOR BAGS

Our Heavy Duty Trash Liners are ideal for lining cans, boxes, compactors, wastebaskets and shredders. Extra thickness makes these the perfect option when nothing else stands up.

TECHNICAL DETAILS

Made from 100% virgin Low and Linear Low-Density Polyethylene. All liners are packaged in cases or wound on rolls with 3" cores. These feature a bottom seal construction.

GUSSETED LINERS

ITEM	W x D x L	MIL	COLOR	CNT	WT
7-10 GALLON					
3269*	15 X 9 X 24	2	BLK	500	35
12-16 GALLON					
3270*	16 X 9 X 30	4	BLK	150	27
20-30 GALLON					
3278*	16 X 14 X 36	2	BLK	250	33
3279*	16 X 14 X 36	3	BLK	200	39
31-33 GALLON					
3283*	23 X 10 X 40	3	BLK	100	24
3284*	23 X 10 X 40	4	BLK	100	32
56 GALLON - GLUTTON					
3291*	25 X 17 X 48	3	BLK	100	36
3285*	25 X 17 X 48	4	BLK	50	24
55-60 GALLON					
3298*	22 X 16 X 60	3	BLK	100	41
3292*	25 X 17 X 54	3	BLK	100	41
3290*	25 X 17 X 54	4	BLK	50	28
3299*	22 X 16 X 60	4	BLK	50	28



ENGINEERED AND MANUFACTURED IN THE U.S.A.

CONTACT US FOR MORE INFORMATION

ALTA-PAK MIDWEST
3401 NORTH JACKSON AVE
KANSAS CITY, MO 64117

TO REORDER CALL 816-453-7204

LINEAR LOW-DENSITY LINERS



DRUM LINERS

Our Drum Liners are ideal for sharp, heavy, or irregular waste.

TECHNICAL DETAILS

Made from 100% virgin Low and Linear Low-Density Polyethylene. These are designed to contain heavy materials. All liners are packaged in cases or wound on rolls with 3" cores and feature a bottom seal construction.

DRUM LINERS – CASES

ITEM	W x L	MIL	COLOR	CNT	WT
55-60 GALLON					
3147*	38 X 60	2	CLR	100	28
3148*	38 X 65	2	CLR	100	30
3150*	38 X 60	3	CLR	100	41
3295*	38 X 60	3	BLK	100	41
3151*	38 X 64	3	CLR	100	44
3152*	38 X 65	3	CLR	100	44
3155*	38 X 60	4	CLR	50	28
3300*	38 X 60	4	BLK	50	28
3302*	38 X 64	4	CLR	50	30
8727*	38 X 65	4	CLR	50	30
8725*	38 X 60	6	CLR	50	43
8730*	38 X 65	6	CLR	50	47
8733*	38 X 65	6	BLK	50	47

DRUM LINERS – ROLLS

ITEM	W x L	MIL	COLOR	CNT	WT
40-45 GALLON					
3305*	40 X 48	3	BLK	100	34
3307*	40 X 48	4	BLK	50	24
55-60 GALLON					
6905*	38 X 65	3	CLR	100	44
6919*	38 X 64	4	CLR	50	29
6920*	38 X 65	4	CLR	50	30
6900*	38 X 72	6	CLR	45	49

BUILD ANY SIZE:

Mil: 1-8 Width: 18"-48" Length: 36"-84"

MORE OPTIONS: **Materials, Film Color, Printing, Venting, Packaging Details**

SPECIALTY CAN LINERS



BIOHAZARD CAN LINERS

Our Biohazard Can Liners are designed for the safe transportation and disposal of medical waste. Printed with a standard biohazard symbol.

TECHNICAL DETAILS

Made from a blend of 100% virgin Linear Low-Density Polyethylene with a metalocene additive. These are certified to exceed 480 grams tear resistance (ASTM D 1922) and 165 grams impact resistance (ASTM D1709), required by D.O.T. Reg. 173.197 for the transport of medical waste. All liners are made with red film and feature a bottom seal construction. Packaged on coreless rolls in convenient dispenser boxes.

ITEM	W x D x L	MIL	BAGS/RL	CNT	WT
7-10 GALLON					
5863	24 X 23	1.3	25/20	500	25
40-45 GALLON					
5874	40 X 46	1.25	15/10	150	24



DUST COLLECTOR

60 GAL LAYFLAT – ROLLS

ITEM	W x L	MIL	COLOR	CNT	WT
6900*†	38 X 72	6	CLR	45	49

† Contains 15% metallocene for added strength.

BUILD ANY SIZE: **Mil: 1-8 Width: 18"-48"**

Length: 36"-84"

MORE OPTIONS: **Film Color, Printing, Venting, Packaging Details**

TIE & TAPE CLOSURES



TWIST TIES

ITEM	LENGTH	CNT	WT
VINYL – WHITE			
4881	4"	2000	1
4883	6"	2000	2
PAPER – WHITE			
4876	4"	2000	1
4891	6"	2000	1
4901	8"	2000	2

SELF-LOCKING, ADJUSTABLE PLASTIC TIES

ITEM	LENGTH	CNT	WT
4903	5"	1000	2



BAG SEALING TAPE

Our Bag Sealing Tape is pressure sensitive, moisture resistant and ideal for securing small and medium sized bags.

TECHNICAL DETAILS

Made from tough polyvinyl chloride and 3/8" wide.

ITEM	COLOR	FT/RL	RL/CS	WT
4720	RED	540	12	4

*smart tech bags®

ENGINEERED AND MANUFACTURED
IN THE U.S.A.

CONTACT US FOR
MORE INFORMATION

ALTA-PAK MIDWEST
3401 NORTH JACKSON AVE
KANSAS CITY, MO 64117

TO REORDER CALL 816-453-7204



POLYPROPYLENE BAGS

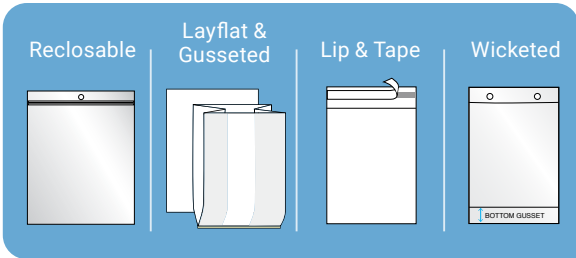

THE BASICS

Our Polypropylene Products are designed with superior clarity to enhance product presentation. A preferred choice for food and retail applications, polypropylene provides highly protective moisture and vapor barrier properties. This delays hydration, keeping food preserved for longer periods of time.

PRODUCT FEATURES:

RECLOSABLE WITH HANG HOLES

- ▶ Crystal clear 2 mil polypropylene
- ▶ Secure zipper closure and side weld construction
- ▶ 1/4" hang hole in lip above zipper

LAYFLAT

- ▶ Crystal clear 1.5 mil polypropylene
- ▶ Side weld construction

GUSSETED

- ▶ Crystal clear 1.5 mil polypropylene
- ▶ Side gussets and bottom seal construction

WICKETED

- ▶ Crystal clear 1 mil polypropylene.
- ▶ Mounted on wickets for manual or automatic loading.

TECHNICAL DETAILS

Made from 100% virgin Polypropylene. Available in reclosable, layflat, gusseted, lip & tape and wicketed constructions. All bags feature a side weld construction and gusseted bags feature a bottom seal construction. These meet FDA/USDA specifications. Available in cases.

Reclosables with Hang Holes

ITEM	W x L	CNT	WT
2 MIL			
13150	3 X 5	1000	3
13155	4 X 6	1000	4
13190	10 X 12	1000	20

Layflat Bags

ITEM	W x L	CNT	WT
1.5 MIL			
13000	3 X 4	1000	1
13005	3 X 5.5	1000	2
13010	4 X 6	1000	2
13015	4.75 X 6.75	1000	4
13020	4.75 X 8.25	1000	5
13025	5.75 X 7.75	1000	5
13030	5.75 X 9.75	1000	6
13035	6.75 X 10.75	1000	7
13045	8 X 10	1000	8
13050	9 X 12	1000	12

Gusseted Bags

ITEM	W x L	CNT	WT
1.5 MIL			
13105	2.5 X 1.25 X 7.5	1000	4
13110	3 X 1.75 X 8.25	1000	4
13115	3.5 X 2.25 X 9.75	1000	6
13120	4.5 X 2.75 X 10.75	1000	8
13125	4.5 X 3.25 X 13	1000	11
13130	5.25 X 3 X 13	1000	11
13135	8 X 4 X 18	1000	22
13140	10 X 8 X 24	500	22

BUILD ANY SIZE:
Mil: 1-4 Width: 4"-30"
Length: 5"-32" Lip: 1.5"-4"
 MORE OPTIONS: **Printing, Venting**

Lip & Tape Bags

Crystal clear 1.6 mil polypropylene, resealable tape closure with side weld construction.

ITEM	W x L	CNT	WT
1.6 MIL WITH 1.5" LIP			
13200	4.125 X 9.5	1000	5
13205	4.375 X 5.75	1000	4
13210	4.75 X 6.5	1000	4
13215	5.25 X 7.25	1000	5
13225	6 X 9	1000	7
13227	7 X 10	1000	9
13235	9 X 12	1000	13
13240	10 X 13	1000	16
13243	11 X 14	1000	18
13247	12 X 16	1000	22
13250	12 X 18	1000	25

BUILD ANY SIZE:
Mil: 1-4 Width: 4"-30"
Length: 5"-32" Lip: 1.5"-4"
 MORE OPTIONS: **Printing, Venting**



Wicketed Bags

Mounted 250 per 5" wicket.

ITEM	W x L	GAUGE	CNT	WT
1 MIL WITH 3" BOTTOM GUSSET				
13310	8 X 22	1 Mil	1000	13
1 MIL WITH 4" BOTTOM GUSSET				
13315	9 X 13	1 Mil	1000	10

CONTACT US FOR
 MORE INFORMATION

ALTA-PAK MIDWEST
 3401 NORTH JACKSON AVE
 KANSAS CITY, MO 64117

TO REORDER CALL 816-453-7204



STAND UP POUCHES

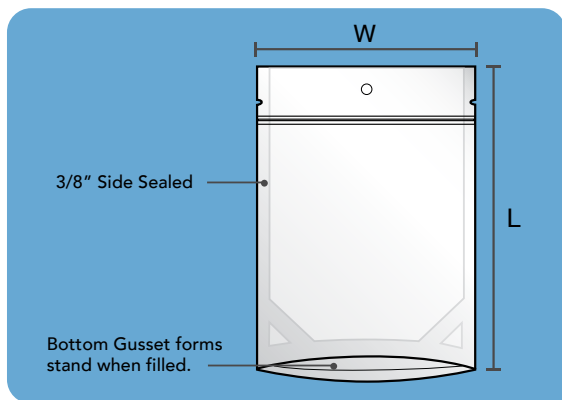

THE BASICS

Our Stand Up Pouches are ideal for food, electronic, cosmetic, retail, medical and other household applications. Designed with superior barrier properties to allow contents to stay fresher longer and constructed so the pouch stands on its own when full.

Choose from Clear Poly Nylon and Clear PET Front/ Silver Metalized Back. Film material specification documents are available upon request.

TECHNICAL DETAILS

Made with multi-layer film for superior barrier protection. All pouches are heat sealable, featuring a K-style construction, 3/8" seals, tear notches at 1", zipper at 1.5" and 1/4" round hang hole. These are USDA and FDA approved. Measured in outside dimensions (O.D.). Available in cases.

CLEAR NYLON POLY

ITEM	W x L	CNT	WT
3 MIL			
6405	5 X 8.5 - 3 BG	1000	13
6410	6 X 9.5 - 3.5 BG	1000	18
6415	7.5 X 11.5 - 3.5 BG	500	12

CLEAR FRONT/SILVER METALLIZED BACK

ITEM	W x L	CNT	WT
3 MIL			
6460	4 X 6 - 2.5 BG	1000	8
6465	5 X 8.5 - 3 BG	1000	13
6470	6 X 9.5 - 3.5 BG	1000	18
6475	7.5 X 11.5 - 3.5 BG	500	13



These pouches are great for R&D, trial, beta testing and market introduction phases of product development.

CONTACT US FOR
MORE INFORMATION

ALTA-PAK MIDWEST
3401 NORTH JACKSON AVE
KANSAS CITY, MO 64117

TO REORDER CALL 816-453-7204

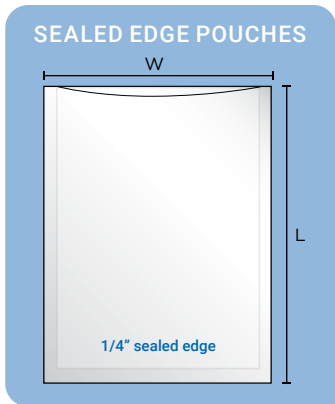

VACUUM POUCHES

STOCK VACUUM POUCHES

THE BASICS

Our Vacuum Pouches are designed for chamber applications. These are popular for food storage, freezer, "bone in," microwave, and boiling applications. Choose from a variety of stock and custom options. Specific application and performance should be evaluated by end user as they apply for suitability.

PRODUCT FEATURES

- ▶ Meet FDA and USDA requirements for food contact
- ▶ Co-extruded Poly/Nylon (PA/PE)
- ▶ MTR < 6 g/sq. m
- ▶ OTR < 60 cc/sq. m
- ▶ Non-channeled for chambered vacuum sealers

TECHNICAL DETAILS

Made from a Poly Nylon blend. All pouches are non-channeled, sealed on three sides and feature a multi-layer construction. Feature a 1/4" seal on three sides and are measured in outer dimensions (O.D.).

3 MIL NON-CHANNELED

ITEM	W x L	CNT	WT
6102	5 X 7	1000	8
6100	6 X 8	1000	10
6105	6 X 10	1000	13
6110	6 X 12	1000	15
6135	8 X 10	1000	17
6140	8 X 12	1000	20
6145	8 X 15	1000	26
6160	10 X 13	1000	28
6165	10 X 15	1000	31
6175	10 X 22	500	23
6185	12 X 12	1000	31
6190	12 X 14	1000	35
6195	12 X 16	500	20
6200	12 X 18	500	27
6210	14 X 16	500	24
6215	14 X 20	500	30
6220	14 X 24	500	36
6225	16 X 20	500	35
6230	16 X 24	500	41
6240	18 X 22	250	19
6245	18 X 28	250	27

NOTE: Measurements are outside dimensions.

CUSTOM VACUUM POUCHES

Choose from a range of multi-layer film blends that best suit your application. These offer some of the best MVTR and OTR in the industry.

PRODUCT FEATURES

- ▶ Meet FDA and USDA requirements for food contact.
- ▶ Co-extruded Poly/Nylon (PA/PE) has multi-layer construction.
- ▶ Laminated Film Options have 2-layer construction.
- ▶ MTR/OTR is variable dependent on which film is chosen.
- ▶ Microwavable, freezable and boilable options
- ▶ Options for "bone-in" application
- ▶ Non-channeled for chambered vacuum sealers
- ▶ 11 Film choices available

CUSTOM FILM OPTIONS

5 CO-EXTRUDED OPTIONS:

- ▶ 3 Mil Poly/Nylon/EVOH - Clear
- ▶ 3 Mil Poly/Nylon - Clear
- ▶ 3.5 Mil Poly/Nylon - Blue
- ▶ 4 Mil Poly/Nylon - Clear
- ▶ 5 Mil Poly/Nylon - Ultra Clear

6 LAMINATED OPTIONS:

- ▶ 3 Mil BON/LLDPE - Clear
- ▶ 3 Mil BON/LLDPE - White
- ▶ 4 Mil BON/LLDPE - Clear
- ▶ 4 Mil BON/LLDPE - Black
- ▶ 5 Mil BON/LLDPE - Clear
- ▶ 5 Mil BON/EVOH/LLDPE - Clear

SIZES AVAILABLE:

DIMENSION	MIN	MAX
Width	4"	30"
Length	6"	48"

- ▶ With or without tear notch
- ▶ 17 day lead time
- ▶ Minimums: 5M with breaks at 10M, 25M and 50M

MORE OPTIONS:

- ▶ Packaging Details

CONTACT US FOR MORE INFORMATION

ALTA-PAK MIDWEST
3401 NORTH JACKSON AVE
KANSAS CITY, MO 64117

TO REORDER CALL 816-453-7204

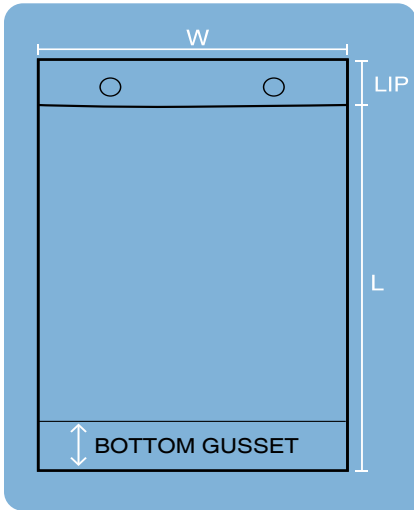

WICKETED BAGS

STOCK WICKETED BAGS

Our Wicketed Bags are designed for fast product hand loading or with automated machinery. Choose from a range of stock and custom options.

POLYPROPYLENE WICKETED BAGS

TECHNICAL DETAILS

Made from 100% virgin Polypropylene with a 1.5" lip. These bags are mounted for manual or automatic loading, 250 per wicket on 5" wickets. All bags are heat sealable, feature a side weld and bottom gusset construction and meet FDA and USDA specifications. Available in cases.

ITEM	W x L	GAUGE	CNT	WT
3" BOTTOM GUSSET				
13310	8 X 22	1 Mil	1000	13
4" BOTTOM GUSSET				
13315	9 X 13	1 Mil	1000	10

POLYETHYLENE WICKETED BAGS

TECHNICAL DETAILS

Made from 100% virgin Low-Density Polyethylene with a 1.5" lip. These are mounted for manual or automatic loading, 250 per wicket on 5" wickets. All bags are heat sealable, feature a side weld and bottom gusset construction and meet FDA and USDA specifications. Available in cases.

ITEM	W x L	GAUGE	CNT	WT
2.5" BOTTOM GUSSET				
8020	7.25 X 13.125	1 Mil	1000	8
8026	9 X 15	1 Mil	1000	11
4" BOTTOM GUSSET				
8030	9.25 X 15.25	1 Mil	1000	12
8037	10 X 15	1 Mil	1000	13
8035	10 X 16	1 Mil	1000	13
8038	11 X 14	1 Mil	1000	13
8039	11 X 17	1 Mil	1000	15
8040	11 X 18	1 Mil	1000	16
8043	12 X 19	1 Mil	1000	19
8046	14 X 20	1.25 Mil	1000	27

**BUILD ANY SIZE: Mil: 1-4 Width: 3"-32"
Length: 5"-43" Lip: 1"-6" Gusset: 2"-8"
MORE OPTIONS: Printing, Venting, Packaging
Details**

CUSTOM WICKETED BAGS

There's never been an easier way to price, order and secure custom wicketed bags. We can help you create bags for fresh produce, baguettes and beyond; we can even quote any printing needed all on the same quote.

Wicketed bags have many parts; these are the specs you need to provide to get accurate quotes quickly.

1. Bag Dimensions: width, length and gauge
2. Bottom Gusset depth if needed
3. Lip Length
4. Bag Release Type: perforated lip or tear starts
5. Wicket Length of 3" to 6"
6. Wicket Width (space between wickets) 3"-9"
7. Cardboard Header: front, back, both or none
8. Bags Per Wicket: 100-350 bags

The custom bag is now complete! We can process your immediate custom quote or add your graphics, text or even just a placeholder, for a fast quote that includes an accurate technical drawing for proofing.

CONTACT US FOR
MORE INFORMATION

ALTA-PAK MIDWEST
3401 NORTH JACKSON AVE
KANSAS CITY, MO 64117

TO REORDER CALL 816-453-7204

SPECIALTY FOOD BAGS

ICE BAGS



Our Ice Bags contain 15% metallocene to provide exceptional strength and flexibility at low temperatures to eliminate breakages.

TECHNICAL DETAILS

Made from 100% virgin Low-Density Polyethylene with 15% metallocene. These exhibit higher tensile strength for cold storage. All bags are heat sealable and feature either a bottom seal or side weld construction.

ITEM	W x D x L	SIZE	MIL	CNT	WT
STANDARD GAUGE					
4984*	6 X 3 X 18	5#	1.25	1000	14
4987*	8 X 3 X 20	8#	1.5	1000	20
4993*	8 X 4 X 22	10#	1.5	1000	24

ITEM	W x L	SIZE	MIL	CNT	WT
HEAVY DUTY					
5000*	18 X 36	50#	3	250	29

**BUILD ANY SIZE: Mil: 0.75-8 Width: 2"-98"
Depth: 2"-72" Length: 3"-288"
MORE OPTIONS: Material, Film Color, Printing,
Venting and Packaging Detail**

SADDLE PACK DELI BAGS

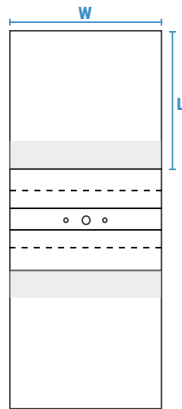

Holes fit standard 3" on center posts.



Our Saddle Pack Deli Bags are designed for high volume food applications, offer excellent barrier properties and are packaged for easy dispensing.

TECHNICAL DETAILS

Made from a blend of 100% virgin Low and Linear Low-Density Polyethylene that meets USDA/FDA specifications. These are available with a 1.5" flip top. All bags come packaged in convenient dispenser boxes and feature a side weld construction.

ITEM	W x L	CNT	WT
0.55 MIL, HIGH-DENSITY			
6705	6.5 X 7	2000	5
6707	8.5 X 8.5	2000	7

SANDWICH & SILVERWARE BAGS



Our Sandwich and Silverware Bags offer enhanced barrier protection to keep food fresher longer.

TECHNICAL DETAILS

Made from a blend of 100% virgin Low and Linear Low-Density Polyethylene that meets USDA/FDA specifications. These are available in a zip top construction or with a 1.5" flip top. All bags come packaged in convenient dispenser boxes and feature a side weld construction.

ITEM	W x L	CNT	WT
0.75 MIL FLIP TOP			
6680	7 X 7 + 1.5" Flip Top	2000	7
1 MIL RECLOSABLE			
6682	6.5 X 6	500	3
0.65 MIL SILVERWARE FLIP TOP			
6670	3.75 X 10 +1.75" Flip Top	2000	4



CONTACT US FOR
MORE INFORMATION

ALTA-PAK MIDWEST
3401 NORTH JACKSON AVE
KANSAS CITY, MO 64117

TO REORDER CALL 816-453-7204

VAPOR CORROSION INHIBITOR



Trusted by over 90% of Fortune 500® industrial companies for more than 40 years

- ARMOR VCI Nanotechnology™ is clean and safe and works faster and longer than other solutions.
- ARMOR VCI self-adjusts to the environment (temperature & humidity), replenishes inside the contained package, and does not alter any important metal properties.



How Does It Work?

Simple. Enclose a metal part inside an ARMOR product and VCI's fill up the vapor space in the packaging. VCI inhibiting ions create a layer of protection only 2-3 molecules thick that repels rust.

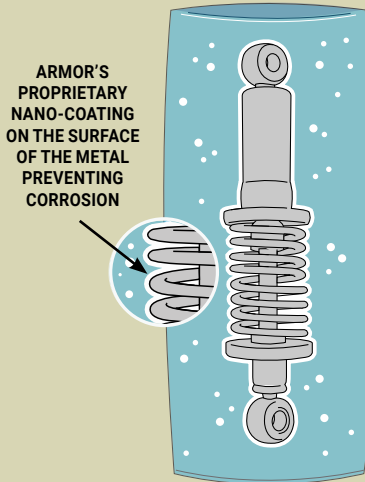

♣ DID YOU KNOW? Most ARMOR POLY VCI Film is made with at least 30% Post-Industrial Recycled Material (PIR). In addition, all ARMOR POLY VCI products are recyclable, as well as the ARMOR WRAP VCI Paper Line (excludes wax and poly-coated items). Sections with products made from 30% PIR are marked with this symbol: ♣

ARMOR POLY® VCI



DEFENDER™ ♣

Made from multi-layer barrier film with VCI. These innovative rust prevention bags provide clean, safe, and easy to use dry packaging of metal products. Due to its unique film construction, the DEFENDER film can be down gauged 25% from standard mono-extruded film for cost savings. All bags are available on rolls with 3" cores, are printed with the ARMOR logo and feature a bottom seal construction.

4 MIL EQUIVALENT LAYFLAT ROLLS				
ITEM	W X L	CNT	WT	MAX. ORDER
14352	24 x 30	250	39	20
14360	36 x 48	150	55	10

3 MIL EQUIVALENT GUSSETED ROLLS				
ITEM	W X D X L	CNT	WT	MAX. ORDER
14415	23 x 15 x 30	250	47	32**
14435	40 x 27 x 60	50	34	20
14445	49 x 46 x 75	50	60	15
14455	52 x 48 x 85	50	67	20**
14464	55 x 50 x 88	40	55	37
14467	58 x 48 x 90	35	52	25**

DEFENDER 3-LAYER FILM

OUTSIDE LAYER ● cost-effective barrier material

CENTER LAYER ● barrier material reduces oxygen and moisture

INSIDE LAYER ● VCI where you need it most

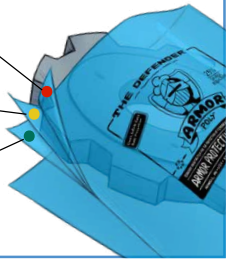

4 MIL EQUIVALENT GUSSETED ROLLS					MAX. ORDER
ITEM	W X D X L	CNT	WT		
14413	20 x 16 x 30	100	23		35
14420	26 x 24 x 46	100	43		16
14422	27 x 20 x 25	100	25		50
14430	34 x 31 x 50	50	35		50***
14432	34 x 33 x 65	50	49		40***
14440	43 x 43 x 70	50	61		16**
14447*	49 x 46 x 90	35	59		20
14457	54 x 44 x 96	25	54		50***
14462	55 x 45 x 80	40	72		32***
14470	58 x 48 x 110	20	52		20**
14475	60 x 54 x 95	30	65		20**
14480	67 x 50 x 72	40	73		12
14487	72 x 46 x 110	25	65		16**

* Item 14447 is clear.

** 1 full pallet | *** 2 full pallets | **** 3 full pallets

CONTACT US FOR MORE INFORMATION

ALTA-PAK MIDWEST
3401 NORTH JACKSON AVE
KANSAS CITY, MO 64117

TO REORDER CALL 816-453-7204

VAPOR CORROSION INHIBITOR

ARMOR POLY® VCI



ARMOR POLY® BAGS

Made from a blend of Low-Density Polyethylene and VCI, these rust-prevention bags provide clean, safe and easy-to-use dry packaging for metal parts. All bags are available on rolls with 3" cores and feature a bottom seal construction.

LAYFLAT CASES					MAX. ORDER
ITEM	W X L	CNT	WT		
3 MIL					
14330	15 x 15	750	30		4
14335	15 x 22	500	30		32**
4 MIL					
14302	4 x 6	5000	29		8
14305	6 x 8	2000	24		20
14310	8 x 10	1000	20		30
14315	9 x 12	1000	26		15
14317	10 x 12	1000	29		20
14320	10 x 15	1000	36		7
14325	12 x 18	500	26		36
14337	16 x 20	500	39		20
14340	18 x 24	250	26		48**
14345	20 x 30	250	36		9
14350	24 x 24	250	35		12
14355	24 x 36	125	26		30

6 MIL ON A ROLL					MAX. ORDER
ITEM	W X L	CNT	WT		
14357*	26 x 66	50	34		15

* Item 14357 is clear.

GUSSETED CASES					MAX. ORDER
ITEM	W X D X L	CNT	WT		
2 MIL					
14405	14 x 10 x 19	500	28		40
2.5 MIL					
14400	12 x 10 x 22	500	38		10
<i>Item 14400 contains an extra-strength additive.</i>					
3 MIL					
14410	16 x 14 x 28	250	38		5
4 MIL					
14402	13 x 11 x 25	250	36		32**
14407	16 x 10 x 21	250	33		64***

GUSSETED ROLLS					MAX. ORDER
ITEM	W X D X L	CNT	WT		
2 MIL					
14442	49 x 43 x 60	100	69		5
14452	50 x 48 x 80	75	74		32***
3 MIL					
14450	50 x 46 x 70	40	51		25**
4 MIL					
14417	23 x 17 x 46	100	46		24**
14425	29 x 29 x 56	50	41		40***
14436	40 x 36 x 80	25	39		50***
14460	55 x 45 x 68	35	61		25**
14465	58 x 48 x 80	25	55		25**
14482	70 x 44 x 100	20	59		32***



RECLOSABLE BAGS

Made from a blend of Low-Density Polyethylene with VCI. These provide clean, safe and easy to use dry packaging of metal parts. All bags are available in cases, are printed with the ARMOR logo and feature a side weld construction.

4 MIL					MAX. ORDER
ITEM	W X L	CNT	WT		
14500	3 x 5	5000	30		5
14505	4 x 6	2000	16		5
14510	6 x 8	2000	31		7
14515	8 x 10	1000	26		6
14520	9 x 12	1000	34		4
14525	10 x 12	1000	36		8
14530	12 x 15	500	27		10
14535	12 x 18	500	31		10
14540	18 x 24	250	30		6

TUBING

Made from a blend of Low-Density Polyethylene with VCI. These provide clean, safe and easy to use dry packaging of metal parts. Available on rolls with 3" cores and printed with the ARMOR logo.

3 MIL					MAX. ORDER
ITEM	W X L	CNT	WT		
14600	5" x 1500'	1	17		15
14605	8" x 1500'	1	27		12
14610	16" x 1500'	1	52		12



ARMOR STRETCH FILM

Made from a blend of Low-Density Polyethylene with VCI. These provide clean, safe and easy to use dry packaging of metal products. Available in banding, hand stretch or machine grade film. All stretch film is puncture resistant, self-clinging and printed with the ARMOR logo. (Note: Top of load must be enclosed with stretch film fully overlapped to contain VCI vapors).

POLY VCI STRETCH FILM					MAX. ORDER
ITEM	W X L	GAUGE	RL/CS	WT	
BANDING FILM					
14200	5" x 900'	100	12	22	12
HAND STRETCH FILM					
14205	18" x 1500'	80	4	35	36**
MACHINE-GRADE STRETCH FILM					
14210	20" x 4500'	100	1	35	120****

♻️ Made with at least 30% Post-Industrial Recycled Material

** 1 full pallet | ***2 full pallets | ****3 full pallets



VCI SHEETING

Made from a blend of High and Low-Density Polyethylene or Low-Density Polyethylene with VCI. These provide clean, safe and easy to use dry packaging of metal products. Ideal for interleaving in returnable trays or applications that require film to conform to a part or cavity. All sheeting is available on rolls with 3" cores.

HD + LD Blend

1.25 MIL PERFORATED SHEETS					MAX. ORDER
ITEM	W X L	CNT	WT		
14655	18 x 18	2500	35		4
14660	36 x 36	1000	51		20**
14665	48 x 48	500	47		24**
14670	48 x 56	500	54		2

Low-Density Sheeting

4 MIL					MAX. ORDER
ITEM	W X L	WT			
14680	36" x 500'	27			15
14685	48" x 500'	38			30
14690	72" x 500'	57			40***

SHRINK FILM

Made from a blend of Linear Low-Density Polyethylene with VCI. These provide clean, safe and easy to use dry packaging of metal products. This film exhibits shrink properties to conform to the product application. All shrink film is available on rolls with 3" cores.

					MAX. ORDER
ITEM	W X L	WT			
4 MIL					
14700	12' x 250'	54			12
14705	20' x 100'	39			40***
6 MIL - UV					
14710	20' x 100'	55			40***

SEA FILM™

Made from a blend of coextruded



Low-Density Polyethylene with UV and VCI. These provide clean, safe and easy to use dry packaging of metal products and protection from harmful UV rays. All film is black on the inside and white on the outside, is available on rolls with 3" cores and is printed with the ARMOR logo.

UV/BLACK IN/WHITE OUT					MAX. ORDER
ITEM	W X L	GAUGE	WT		
14715	20' x 100'	10 mil EQ	83		16**
14717	20' x 100'	6 mil EQ	43		6

CONTACT US FOR MORE INFORMATION

ALTA-PAK MIDWEST
3401 NORTH JACKSON AVE
KANSAS CITY, MO 64117

TO REORDER CALL 816-453-7204

VAPOR CORROSION INHIBITOR

ARMOR WRAP® VCI



ARMOR WRAP

Made from virgin neutral PH paper with a VCI additive. These are coated on both sides with ARMOR VCI Nanotechnology to provide clean, safe and easy to use dry packaging of metal products. All paper sheets are packaged flat in cases and paper rolls are on 3" cores. Printed with the ARMOR logo.

VCI 30# Paper Sheets

ITEM	W X L	CNT	WT	MAX. ORDER
14800	4 x 4	5000	10	10
14805	6 x 6	2000	8	25
14810	9 x 9	1000	8	64**
14815	9 x 12	1000	9	40
14825	10 x 15	1000	14	40**
14830	12 x 12	1000	13	63**
14835*	12 x 12	1000	14	20
14845	12 x 24	1000	27	15
14850	18 x 18	1000	28	20**
14855	18 x 24	1000	42	10
14860	24 x 24	1000	52	10**
14865	24 x 36	1000	78	5**
14870	36 x 36	1000	112	5**
14875	40 x 48	1000	164	5**
14885	48 x 48	1000	196	2

Items 14860-14885 come Tabbed on a skid.



VCI 30# Paper Rolls

ITEM	W X L	CNT	WT	MAX. ORDER
14900	12" x 200 yds	3	26	36
14905	18" x 200 yds	2	26	7
14910	24" x 200 yds	2	33	30**
14915	36" x 200 yds	1	26	60***
14920*	36" x 200 yds	1	26	15
14925	36" x 200 yds	1	31	20
14927	36" x 500 yds	1	60	16**
14930	48" x 200 yds	1	33	30**
14933	48" x 500 yds	1	78	16**

Item 14925 offers extra strength with a Wax Barrier on one side and VCI on the other.

SCRIM - FIBERGLASS REINFORCED PAPER

14931	48" x 200 yds	1	58	8
14935	60" x 200 yds	1	73	5

* Items 14835 and 14920 have MPI (Multi-Purpose Inhibitor) Corrosion Prevention for effective use on specialty metals like bronze, zinc, and aluminum.

ARMOR SHIELD® VCI



ARMOR SHIELD CLAY TYVEK® DESICCANTS

Made from Silica Gel or Clay. These reduce humidity and moisture inside an enclosed space. With proper use, desiccants will both maintain and/or lower the humidity level within packaging or a container for an extended period of time. All desiccants are packaged in a sturdy Tyvek material to avoid punctures or tears. These are FDA, USDA and Military approved.

ITEM	SIZE	CNT	WT	MAX. ORDER
15010	1/6 oz.	1200/pail	21	24
15015	1/3 oz.	700/pail	23	48
15020	1/2 oz.	550/pail	26	30
15025	1 oz.	300/pail	28	48
15030	1 oz.	1300/drum	109	15
15035	2 oz.	150/pail	28	48
15040	2 oz.	800/drum	132	5
15045	4 oz.	500/drum	161	10
15050	8 oz.	300/drum	190	15
15055	16 oz.	150/drum	189	15
SEWN CLOTH				
15060	16 oz.	150/drum	188	5
15065	80 oz.	30/drum	184	10

ARMOR SHIELD SILICA GEL TYVEK DESICCANTS

ITEM	SIZE	DIM	CNT	WT	MAX. ORDER
15070	10 gm.	1.5" x 3.25"	1500	34	15
15072	1 oz.	3" x 4"	300	19	12



Items 14931 and 14935 are triple reinforced with fiberglass scrim, moisture barrier, and VCI for use with sharp edges and corners on large, bulky objects.



ARMOR SHIELD SMARTY PAK™ VCI & DESICCANT

SMARTY PAK is uniquely designed to prevent rust in two ways. It is one part emitter to release ARMOR VCI Nanotechnology™ to form a protective shield of the surface of metal and one part desiccant to remove humidity and moisture from the packaging or storage environment. SMARTY PAK is available in three sizes, packaged in Tyvek material for puncture and tear resistance, and is non-dusting and lint free for use in applications where fibrous packaging materials are not allowed.

ITEM	COVERAGE	CNT	WT	MAX. ORDER
15075	1-4 Cu. Ft.	900	20	6
15080	4-10 Cu. Ft.	300	20	10
15085	10-35 Cu. Ft.	75	20	15



ARMOR SHIELD VCI FIBERBOARD CHIPS

Made from 30 Pt Chipboard with a VCI additive. These combine the benefit of VCI with chipboard for clean, safe and easy to use dry packaging of metal products. Ideal for small parts where a non-VCI bag may be used or any small areas requiring additional VCI. Packaged in cases.

ITEM	W X L	CNT	WT	MAX. ORDER
15100	1 x 1	2500	2	25
15105	1 x 1	25000	24	40

TYVEK® is a registered trademark of DOW Chemical.

** 1 full pallet | ***2 full pallets | ****3 full pallets

CONTACT US FOR MORE INFORMATION

ALTA-PAK MIDWEST
3401 NORTH JACKSON AVE
KANSAS CITY, MO 64117

TO REORDER CALL 816-453-7204

VAPOR CORROSION INHIBITOR

ARMOR SHIELD® VCI

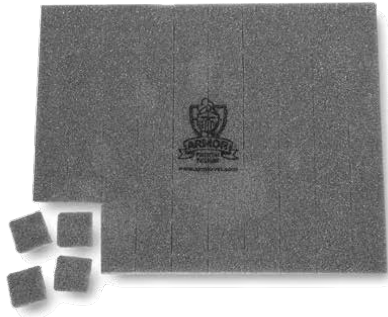

ARMOR SHIELD VCI FOAM PADS

Made from Polyurethane Foam with a VCI additive. These are embedded with ARMOR VCI Nanotechnology for clean, safe and easy to use dry packaging of metal products. Replaces oils and greases and is ideal for parts needing cushioning or additional VCI in an enclosed space. Packaged in cases.

ITEM	W X L X D	CNT	WT	MAX. ORDER
15115	1 x 1 x 1/4	2000	2	20
15120	2 x 5 x 1/4	1000	6	20
15125	10 x 10 x 1/4	250	10	10



ARMOR SHIELD CF33 EMITTER

Made from compressed Polyurethane Foam with a VCI additive. These are embedded with ARMOR VCI Nanotechnology for clean, safe and easy to use dry packaging of metal products. Replaces oils and greases and is ideal for electrical or mechanical cabinets, returnable trays or any parts needing additional VCI rust protection in an enclosed space. Packaged in cases.

ITEM	W X L X D	COVERAGE	CNT	WT	MAX. ORDER
15130	4 1/8 x 3 1/4 x 3/8	33 Cu. Ft.	10	1	60

ARMOR® LIQUIDS & SOLUTIONS



METAL RESCUE® RUST REMOVER

Made from a water-based rust remover liquid soak. This provides a clean, safe and easy solution for removing rust on ferrous metals. Rust can be removed in 5 minutes to 24 hours depending on the type of metal and severity of rust. This product is non-hazardous and biodegradable, containing no harsh acids and is safe on other materials including rubber, elastomers, plastic or glass.

ITEM	SIZE	CNT	WT	MAX. ORDER
RUST REMOVER BATH				
14955	5 gal.	1	45	30
14960	55 gal.	1	502	4
14965	330 gal.	1	2700	1
RUST REMOVER GEL WITH CITRIC ACID				
14967	2 gal.	1	20	25



DRY COAT™ RUST PREVENTATIVE

Made from a water-based rust preventative liquid. This is a clean, safe and easy-to-use replacement for oil-based or solvent corrosion inhibitors. Apply via dip, spray or flow coat at ambient conditions and Dry Coat will dry to the touch in minutes. Upon drying, Dry Coat leaves a protective rust preventative coating that is not sticky or tacky and does not attract dirt or dust. Dry Coat is easily removed with soap and water or mild detergents. Designed for indoor storage of parts up to one year.

ITEM	SIZE	CNT	WT	MAX. ORDER
3-6 MONTH PROTECTION				
14980	5 gal.	1	47	15
14985	55 gal.	1	500	4
14990	330 gal.	1	2764	1
14993	55 gal.	1	500	4
14995	330 gal.	1	2764	1

CONTACT US FOR MORE INFORMATION

ALTA-PAK MIDWEST
3401 NORTH JACKSON AVE
KANSAS CITY, MO 64117

TO REORDER CALL 816-453-7204



PRINTING

YOUR BAG, YOUR WAY.

CUSTOM PRINTING MADE EASY WITH FAST QUOTES AND PDF PROOF

Custom printing is made simple from complex professional images to simple text, you can rely on our skilled partners to get your printing right. Choose to print on one, two or sometimes three sides (bottom gussets, too). Quotes even include precise technical line drawings that are made available for exact visual of how your print will be positioned and colored, all in a PDF attachment for your customer's review and approval.

PICK A PRINTING STYLE



REGISTERED PRINTING

With our Registered printing you designate the exact placement of an image and text on a bag. Artwork may range from single color images to photo-quality multi-color print with the ability to utilize both PMS spot and CMYK process colors.

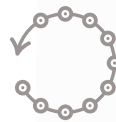

RANDOM REPEAT PRINTING

We offer random repeat printing on our bags, film and tubing with one color, one side. This economical style of printing repeats an image or block of text a specified distance apart, with at least one image guaranteed per bag. Due to the nature of Random Repeat printing, images may land on on the seal and perforations that separate bags.

CONTACT US FOR
MORE INFORMATION

ALTA-PAK MIDWEST
3401 NORTH JACKSON AVE
KANSAS CITY, MO 64117

TO REORDER CALL 816-453-7204

PRINTING

THERE FROM START TO FINISH

Our skilled representative will work with you every step of the way to create a great looking bag to your exact specifications. This ensures a smooth printing process, from proof approval to order completion. If you need help reworking your art, we can help with that, too.

Note: Printed bags made to your approved specification are not eligible for return.

NO ARTWORK? NO PROBLEM!

WE HAVE A SOLUTION FOR THAT.

We can still get you a quote before your artwork is completely done. Just send us the size, number of colors and worry about the artwork later. We also have a number of commonly used Stock Images shown below. If your printed bag just needs a short typed message, we can get that for you, too – just supply your text with the size exactly how you want it to appear.

STOCK IMAGES

Available for both **Registered** and **Random Repeat** Printing.

WARNING: To avoid danger of suffocation, keep this plastic bag away from babies and children. Do not use this bag in cribs, beds, carriages or playpens. This bag is not a toy.
ADVERTENCIA: Para evitar el riesgo de asfixia, mantenga esta bolsa plástica fuera del alcance de bebés y niños. No utilice esta bolsa en cunas, camas, coches o corrales. Esta bolsa no es un juguete.
AVERTISSEMENT: Pour éviter tout risque d'étouffement, gardez ce sac en plastique à partir des bébés et des enfants. Ne pas utiliser ce sac dans des berceaux, des lits, des voitures ou des parcs. Ce sac n'est pas un jouet.

Suffocation Warning, 14 or 24 pt. text



Recycle 2" x 2"



BIOHAZARD

Biohazard 6" x 6"



VCI 2.5" x 2.5"

Quotes include precise technical line drawings for instant sharing in a PDF attachment.

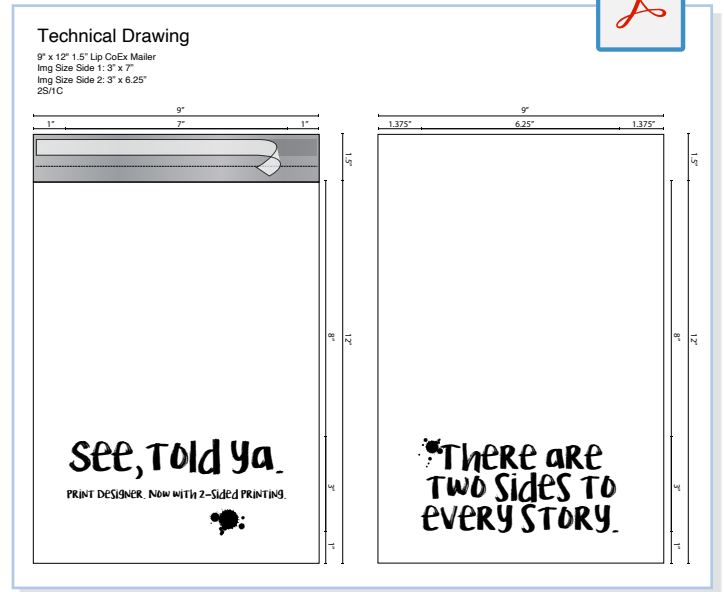

CUSTOM INK COLORS

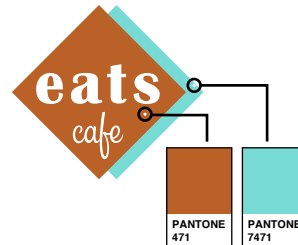

PMS Spot Colors

Logos and simple images using solid ink colors are reproduced using one printing plate per color. Choose from thousands of spot colors using the Pantone Matching System (PMS) available online.

Note: Please have PMS colors chosen prior to submittal of artwork.



CMYK Process Colors

Photos and illustrations are reproduced by a printing process using a combination of Cyan, Magenta, Yellow and Black ink dots to create unlimited colors. These require White ink as well when printing on a clear substrate such as poly film.

RANDOM REPEAT INKS



(SWATCHES ARE APPROXIMATE)

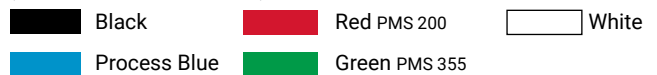

CONTACT US FOR MORE INFORMATION

ALTA-PAK MIDWEST
 3401 NORTH JACKSON AVE
 KANSAS CITY, MO 64117

TO REORDER CALL 816-453-7204

MEASURING FOR THE RIGHT SIZE

LAYFLAT BAGS SQUARE CONTAINER OR DIMENSIONAL PRODUCT

Note: Depth is the shorter of the 2 sides.

1. Bag Width = Container Width + Container Depth + 2" for a looser fit.
2. Bag Length = Container Height + Container Depth + 6" to cover contents and tie the bag closed.

EXAMPLES

Container Size: 14" W x 10" D x 32" L

Bag Size: 26" W x 48" L

Object Size: 10" W x 3" D x 16" L

Bag Size: 15" W x 25" L



ROUND CONTAINER

1. Container Circumference = Diameter x 3.14
2. Bag Width = Container Circumference divided by 2, + 1" for a looser fit.
3. Bag Length = Container Height + Container Diameter + 6" for overhang.

EXAMPLE

Container Size: 12" D x 30" L

Bag Size: 20" W x 47" L

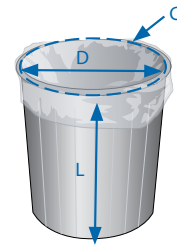

GUSSETED BAGS SQUARE CONTAINER OR DIMENSIONAL PRODUCT

GUSSETED BAG – PALLET COVER

WIDTH = wider side
DEPTH = shorter side
HEIGHT = height of block or container

1. Cover Width = **Pallet Width** + 2"
2. Cover Depth = **Pallet Depth** + 2"
3. Cover Length = **Pallet Height** + 1/2 **Pallet Depth**

Example: Pallet Size: 40" W x 36" D x 50" L
 Cover Size: 42" W x 38" D x 68" L

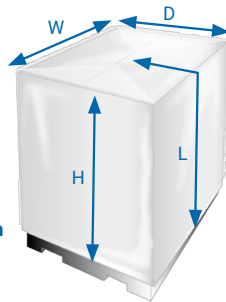

GUSSETED BAG – GAYLORD LINER

WIDTH = wider side
DEPTH = shorter side
HEIGHT = height of block or container

1. Bag Width = **Box Width** + 1"
2. Bag Depth = **Box Depth** + 1"
3. Bag Length = **Box Height** + **Box Depth** + 6" to cover contents and tie the bag closed.

Example: Box Size: 18" W x 12" D x 14" L
 Bag Size: 19" W x 13" D x 32" L

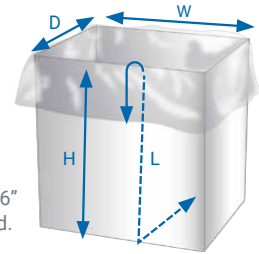

RECLOSABLE BAGS

RECLOSABLE BAG

Note: Domestically produced custom reclosables come with reinforced hammerseals; our standard stock reclosables and imported custom reclosables do not.

1. Bag Width = Width of Product + 1 1/2"
2. For rigid items, add 1/2" more to the width of the bag to allow the item to fit.
3. Bag Length = Length of product + 1"
4. For thick or bulky items add the Depth of the product to both Width and Length.
5. Add 1/2" to 2" to both dimensions for a looser fit.

EXAMPLE

Flat Product: 2 1/2" W x 5" H

Bag Size: at least 4" W x 6" L

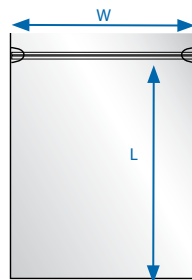

SLIDER TOP BAG

1. Bag Width = Width of Product + 1 1/2"
2. For rigid items, add 1/2" more to the width of the bag to allow the item to fit.
3. Bag Length = Length of product + 1/2"
4. For thick or bulky items add the Depth of the product to both Width and Length.
5. Add 1/2" to 2" to both dimensions for a looser fit.

EXAMPLE

Flat Product: 2 1/2" W x 5 1/2" H

Bag Size: at least 4" W x 6" L

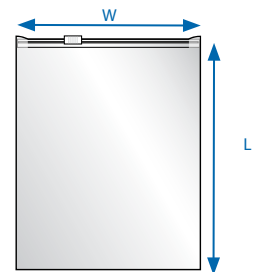



CUSTOM MANUFACTURING

Bags, film and tubing are made through a process called blown film extrusion. It's where polyethylene is melted and extruded vertically into a bubble which then makes its way downstream to be slit, folded or sealed.

In addition to over 58 extrusion lines in 5 manufacturing facilities, we offer extensive capabilities through 30 other partner plants. We can produce bags, tubing and sheeting in a wide array of materials, sizes and constructions, all built to your specification. Choose from 16 standard colors, 3 venting styles, printing capabilities and a host of performance additives to create your custom-tailored product.

MADE IN THE U.S.A.

Smart Tech Bags® are manufactured with 100% renewable energy and are engineered to provide over three times the impact and twice the tensile strength of traditional low-density polyethylene bags. Exclusively manufactured in the U.S.A. by an ISO 9001 registered provider.

MATERIALS & ADDITIVES

- Anti-Block** For easy opening and loading
- Anti-Static** For static-dissipative film
- Clarity** For improved visibility through film
- HDPE** High-Density Polyethylene for thinner, more economical film
- High Slip** For reduced friction between film
- LDPE** Low-Density Polyethylene for standard strength film
- LLD** High Strength Linear Low-Density
- LLDPE** Linear Low-Density Polyethylene for high strength film
- Metallocene** For high strength film or cold storage
- Non-Slip** To increase friction between film
- Non-Scratch** No anti-block for a smoother film surface
- Postal-Approved** Higher slip & anti-static for film used in USPS mailings
- UVI/UVA** Ultraviolet Inhibitor/Absorber to protect film and contents from the sun
- VCI** Vapor Corrosion Inhibitor to prevent rust

FILM COLORS & VENTING

- FILM COLORS** 16 Colors available as tint, color, or opaque
- VENTING** Standard 1/4" round, 1/4" Butterfly, or Microperforation

FAST QUOTES

Getting pricing and lead times has never been easier or faster. Just contact us with your exact specifications.

BAG, TUBING & SHEETING STYLES

Layflat & Gusseted Bags

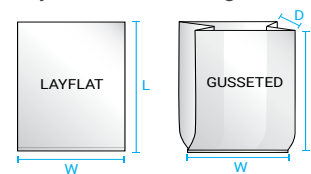

Reclosable Bags

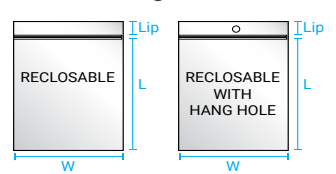

Continuous Tubing & Sleeves

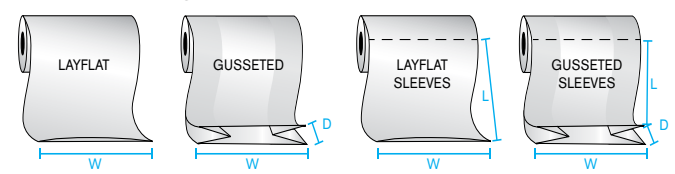

Continuous Sheeting*

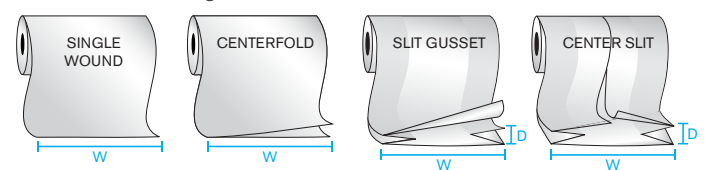

PACKAGING DETAILS

CASES OR ROLLS Loose in a case or on a roll for easy dispensing

CASE OR ROLL COUNT Get the quantity that works best for your customer

BOXED ROLLS Boxed Rolls protect product prior to use

TRAY-PACKED ROLLS Use less packaging, saves time unpacking.

CRADLE PACKED ROLLS Use less packaging, save money and provide more stable shipments.



CONTACT US FOR
MORE INFORMATION

ALTA-PAK MIDWEST
3401 NORTH JACKSON AVE
KANSAS CITY, MO 64117

TO REORDER CALL 816-453-7204